

## “GLOBAL DYNAMICS” OF A TEMPERATE VALLEY GLACIER, MER DE GLACE, AND PAST VELOCITIES DEDUCED FROM FORBES’ BANDS

By LOUIS LLIBOUTRY and LOUIS REYNAUD

(Laboratoire de Glaciologie du C.N.R.S. et Université de Grenoble I, 2, rue Très-Cloîtres,  
38031 Grenoble Cédex, France)

**ABSTRACT.** Transverse profiles and velocities which have been measured on the ablation zone of Mer de Glace more or less continuously since 1891 contradict the Weertman–Nye theory of glacier kinematic waves. Faint broad waves, which undoubtedly result from fluctuations in the balance, travel down the glacier faster than this theory predicts. (This theory having first been completed by taking changes in width with time and with distance down the glacier into account.) On the other hand, velocity fluctuations are synchronous and more or less the same over the entire length studied (6 km).

These discrepancies result from bottom friction being of the solid type, i.e. independent of sliding velocity. Friction should also be almost insensitive to discharge in subglacial waterways, since in the steady state energy for keeping them open, not entirely flooded, and at atmospheric pressure, is superabundant. The sliding velocities at all cross-profiles are thus controlled by some areas where the body of the glacier suffers strong deformation because the valley shape is far from cylindrical. One such controlling zone exists on Mer de Glace owing to the existence of a subglacial transverse shoulder. A new perturbation equation and a new rough expression for wave velocity are given.

Intervals between Forbes’ bands were plotted on seven aerial surveys between 1939 and 1979. Progressive tilting of the slices of blue, dusty ice from the position from which these dark bands proceed and progressive lowering of their exposed edge must be taken into account. This analysis confirms the validity of our simple model for velocity fluctuations and allows us to estimate the entire series since the year 1888.

**RÉSUMÉ.** “*Dynamique globale*” d’un glacier de vallée tempérée, la Mer de Glace, et vitesses dans le passé à partir des Bandes de Forbes. Les profils transversaux et les vitesses qui ont été mesurés en zone d’ablation de la Mer de Glace de façon plus ou moins continue depuis 1891 contredisent la théorie de Weertman–Nye des ondes cinématiques glaciaires. Des vagues faibles et étalées, résultant sans aucun doute des fluctuations de bilan, descendent le glacier plus vite que ne le prévoit cette théorie (théorie préalablement complétée pour tenir compte des variations de largeur le long du glacier et au cours du temps). Par ailleurs les fluctuations de vitesse sont synchrones et plus ou moins les mêmes sur toute la longueur étudiée (6 km).

Ces discordances proviennent de ce que le frottement obéit à une loi de type solide, c’est-à-dire est indépendant de la vitesse de glissement. Le frottement doit aussi être à peu près insensible aux débits dans les chenaux sous-glaciaires, car, en état de régime, l’énergie nécessaire pour les maintenir ouverts, non entièrement noyés et à la pression atmosphérique est surabondante. Aussi les vitesses de glissement à toutes les sections transversales sont-elles contrôlées par quelques zones où le corps du glacier doit beaucoup se déformer parce que la vallée n’y a pas une forme cylindrique. Une telle zone de contrôle existe sur la Mer de Glace, par suite de l’existence d’un épaulement sous-glaciaire. Une nouvelle équation aux perturbations et une nouvelle expression approchée pour la vitesse des vagues sont fournies.

Les intervalles entre les bandes de Forbes ont été tirés de sept couvertures aériennes successives entre 1939 et 1979. Il faut tenir compte du basculement progressif des tranches de glace bleue et poussiéreuse d’où proviennent ces bandes brunes et de l’abaissement de leur bord exposé. Cette analyse confirme la validité de notre modèle simple pour les fluctuations de vitesse et permet d’en estimer l’entière série depuis 1888.

**ZUSAMMENFASSUNG.** “*Globale Dynamik*” eines temperierten Talgletschers, Mer de Glace, und frühere Geschwindigkeiten, hergeleitet aus Forbes-Bändern. Querprofile und Geschwindigkeiten, die in der Ablationszone des Mer de Glace mehr oder minder kontinuierlich seit 1891 gemessen wurden, widersprechen der Theorie der kinematischen Wellen auf Gletschern von Weertman–Nye. Schwache, breite Wellen, die zweifellos von Schwankungen in der Massenbilanz stammen, wandern schneller über den Gletscher hinab, als diese Theorie voraussagt. (Zuvor wurde diese Theorie durch Berücksichtigung von zeitlichen und räumlichen Breitenänderungen gletscherabwärts ergänzt.) Andererseits sind die Geschwindigkeitsschwankungen gleichzeitig und mehr oder weniger gleich gross über den ganzen untersuchten Abschnitt (6 km).

Diese Unstimmigkeiten werden durch die Reibung am Untergrund verursacht, die fest, d.h. unabhängig von der Gleitgeschwindigkeit ist. Die Reibung sollte auch beinahe unempfindlich gegen den Abfluss in subglazialen Wasseradern sein, da im stationären Zustand Energie zu deren Offenhaltung ohne totale Füllung und unter Atmosphärendruck im Überfluss zur Verfügung steht. Die Gleitgeschwindigkeit in allen Querprofilen wird dann durch einige Gebiete bestimmt, wo der Gletscherkörper infolge des beträchtlichen Abweichens des Talprofils von der Zylinderform starke Deformationen erfährt. Eine solche Zone gibt es im Mer de Glace infolge der Existenz einer subglazialen Querschwellen. Eine neue Störungsgleichung und ein neuer Näherungsausdruck für die Wellengeschwindigkeit werden angegeben.

Die Zwischenräume zwischen Forbes-Bändern wurden aus Luftbildern von sieben Befliegungen zwischen 1939 und 1979 ausgewertet. Die fortschreitende Biegung der Scheiben blauen, verschmutzten Eises, aus denen diese dunklen Bänder treten, und die ständige Erniedrigung ihres oberen Randes müssen berücksichtigt werden. Die Analyse bestätigt die Gültigkeit unseres einfachen Modells für die Geschwindigkeitsschwankungen und gestattet die Abschätzung der ganzen Serie seit dem Jahre 1888.

## 1. INTRODUCTION

Our aim is to acquire quantitative knowledge, allowing prediction, of how a temperate valley glacier reacts to fluctuations in its balance.

This quite old problem has hitherto been treated by considering flow in a cylindrical channel parallel to  $Ox$ , assuming no variation with  $x$  of stresses and strain-rates, and assuming the Weertman friction law as lower boundary condition. Although neither the initial perturbation equation nor the corresponding solutions have ever been confirmed quantitatively by field measurements (the only two cases studied by Nye (1965[b]) being inconclusive), and although the starting assumptions conflict with the field evidence (Meier, 1968, for instance), the theory had become classical and has delighted theorists and teachers for over fifteen years.

In this article the sole case of Mer de Glace, in the French Alps, will be considered to point out conflicting results. Nevertheless we hope that our new simple model, which proves to be quite satisfactory for Mer de Glace, will be of a much broader value.

In the first section, the classical Weertman–Nye theory of kinematic waves will be described. In the second section it will be shown that field evidence contradicts this theory.

Thus, in the third section quite different assumptions will be suggested: the friction law is not Weertman's one, and longitudinal stresses are transmitted over large distances. As a consequence of this second fact the whole of Mer de Glace between the big ice fall called "séracs du Géant" and the snout should be considered as a whole, and what we call "global dynamics" will be introduced. This leads us to consider separately fluctuations in thickness, which travel down the glacier, and fluctuations in velocity, which are synchronous all over the glacier. For the latter a very simple linear model is put forward.

In the final section this new model is checked by considering the intervals between Forbes' bands from widely differing years.

## 2. THE CLASSICAL THEORY OF WEERTMAN AND NYE

### 2.1. *Main assumptions and equations*

L. de Marchi (1911) was the first to point out, in 1895, that the existence of a relation between the cross-section area of a valley glacier and the discharge through this cross-section leads to the existence of waves, which have been called kinematic waves since the article of Lighthill and Whitham (1955). The theory of these waves was developed by S. Finsterwalder (1907) with the assumption that the mean ice velocity is proportional to the square root of the thickness, as is the case for the water in rivers (Chezy's relation).

Weertman (1958) rediscovered kinematic waves, and pointed out their diffusion owing to the relation existing between discharge and surface slope. He assumed that all motion was due to sliding, the sliding velocity being related to basal shear stress by the power law he had introduced the year before.

Nye (1960, 1963[a], [b], 1965[b]) developed this theory, which will first be briefly presented and extended to allow further discussion.

Let  $q(x, t)$  be the glacier discharge through a cross-section at abscissa  $x$  and time  $t$ ,  $S(x, t)$  be the area of this cross-section,  $\mathcal{I}(x, t)$  be the width of the glacier surface and  $\tan \alpha \ll 1$  its slope. The annual balance at the surface (in metres of ice), averaged over the cross-section, is denoted  $b(x, t)$ . In what follows the subscript zero denotes steady-state values, and subscript one a small perturbation. Volume conservation gives

$$\partial q_1 / \partial x + \partial S_1 / \partial t = \mathcal{I}_0 b_1 + b_0 \mathcal{I}_1. \quad (1)$$

Let  $h(x, t)$  be the maximum thickness over a cross-section. Assuming the slopes on the right and left side of the cross-section to be  $m_r$  and  $m_l$ , and putting

$$\frac{b_0}{\mathcal{I}_0} \left( \frac{1}{m_r} + \frac{1}{m_l} \right) = e_0, \quad (2)$$

the perturbation equation (2) becomes

$$\frac{\partial S_1}{\partial t} = Y_0 b_1 + e_0 S_1 - \frac{\partial q_1}{\partial x} \tag{3}$$

A crucial assumption (to be challenged in this article) is now made: the discharge  $q(x, t)$  is assumed to be a well-defined, single-valued function of  $S(x, t)$  and  $\alpha(x, t)$  only. Then by putting

$$\frac{\partial q}{\partial S}_0 = \frac{1}{Y_0} \frac{\partial q}{\partial h}_0 = c_0, \quad \frac{1}{Y_0} \frac{\partial q}{\partial \alpha}_0 = D_0, \tag{4}$$

the linearized perturbation equation becomes

$$\frac{\partial h_1}{\partial t} = b_1 + \left( e_0 - c_0' - \frac{c_0}{Y_0} Y_0' \right) h_1 - \left( c_0 - D_0' - \frac{D_0}{Y_0} Y_0' \right) \frac{\partial h_1}{\partial x} + D_0 \frac{\partial^2 h_1}{\partial x^2} \tag{5}$$

(the primes representing differentiation with respect to  $x$ ).

Near the snout in general  $c_0'$  and  $(c_0/Y_0) Y_0'$  are negative and of the same order of magnitude. Although  $e_0$  is negative, it is quite insufficient to restore stability, unless the glacier ends in a flat area. (Only  $c_0'$  was considered in Nye’s theory.)

As a first rough model, the same perturbation  $b_1(t)$  over the whole glacier may be assumed (Lliboutry, 1974). The problem is then to know the glacier response to a unit impulse ( $b_1 = 1$  for a single year). As long as finite-amplitude effects (Lick, 1970) and feed-back (Lliboutry, 1964-65, p. 731-65) remain negligible, the general response will be obtained by next convoluting this response to an impulse with the annual input  $b_1(t)$ . This problem and its inverse have been solved by Nye (1965[b]) by the Crank-Nicholson method.

2.2. Velocity of kinematic waves

The velocity of kinematic waves in cylindrical channels when sliding is negligible has been computed by Nye (1965[a]). He used Glen’s law for ice creep, namely

$$2\dot{\epsilon}_{ij} = A \left[ \frac{1}{2} \sum_{i,j} (\tau_{ij}')^2 \right]^{(n-1)/2} \tau_{ij}' \tag{6}$$

where  $\dot{\epsilon}_{ij}$  are the strain-rates and  $\tau_{ij}'$  the deviatoric stresses. The value  $n = 3$ , well confirmed by Duval’s (1981) laboratory experiments is adopted. Velocities are given in dimensionless form, with  $U = hA(\rho gh \sin \alpha)^3$  as unity. Nye’s results for a parabolic cross-section (indeed the most common in mountain valley glaciers) are given in Table I. Since the ratio

TABLE I. VELOCITIES IN A CYLINDRICAL CHANNEL WITH PARABOLIC CROSS-SECTION AND NO SLIDING

$W$	0	1	2	$\infty$
No slip and $n = 3$ (Nye, 1965[a])				
$u_m/U$	$W^4/4$	0.022 1	0.067 5	0.250
$\bar{u}/u_m$	0.343	0.674	0.652	0.443
$\bar{u}/\bar{u}_s$	0.429	0.837	0.980	1.091
$c_0/u_m$	0.800	2.03	2.14	1.625
$c_0/\bar{u}$	2.333	3.01	3.28	3.667
Plug flow ( $u_m = \bar{u} = \bar{u}_s = u_b$ ) and Weertman’s law of sliding: $u_b = k\tau_b^m$				
$c_0/u_m = c_0/\bar{u}$	$m+0.333$	$m+0.496$	$m+0.589$	$m+0.667$

$\mathcal{Y}/(2h) = W$  is in the range 1 to 2 for Alpine valley glaciers,  $c_0/u = 3.0$  to 3.3 in the case of no sliding.

The model of a triangular cross-section fits rather well the lower part of many large mountain glaciers: Mer de Glace, Glacier d'Argentière, Glacier Blanc (Massif des Ecrins, French Alps). Provided we assume negligible sliding, the velocity of kinematic waves for a triangular (not necessarily symmetric) cross-section can be calculated easily, because any variation in  $h$  does not change the shape of the glacier cross-section. For a given slope the discharge varies as  $h^{n+3}$ , the cross-section area as  $h^2$ , and then

$$\begin{aligned} c_0 &= \frac{\partial q}{\partial S} = \frac{q}{S} \frac{1}{q} \frac{\partial q}{\partial h} \left/ \left( \frac{1}{S} \frac{\partial S}{\partial h} \right) \right. \\ &= \bar{u} \frac{n+3}{2}. \end{aligned} \quad (7)$$

Nevertheless, as already recognized by Nye (1958), sliding is predominant in most valley glaciers. In his following papers he adopted Weertman's friction law. This law may be plainly introduced by dimensional considerations (Lliboutry, 1979). If we assume that: (1) at a given point, there exists a well-defined relation between the bottom shear stress  $\tau_b$  and the sliding velocity  $v$ ; (2) ice creep follows Glen's law; (3) the bed is rock with the same heat conductivity as ice; (4) the microrelief of the bed is statistically dimensionless; then the friction law must be

$$\tau_b = kv^{1/m} \quad (8)$$

with  $m = (n+1)/2$ . We may consider the extreme case of negligible body deformation (plug flow). The velocity of kinematic waves for a parabolic cross-section is given in Table I. For a triangular cross-section,  $\tau_b \propto h$ , whence  $v \propto h^{m+1}$ ,  $q \propto h^{m+3}$  and

$$c_0/v = (m+3)/2. \quad (9)$$

Since the real situation is an intermediate one between no sliding and plug flow, the ratio  $c_0/u$  should be between 2.5 and 3.3, and the ratio  $c_0/u_m$  between 2.0 and 2.6. Nevertheless we must not forget that the measured kinematic wave velocity, according to Equation (5), is  $c_0 - D_0' - (D_0/\mathcal{Y}_0) \mathcal{Y}_0'$ . Both corrective terms will be calculated in due time.

### 3. OBSERVATIONS ON MER DE GLACE

#### 3.1. Field work

Mer de Glace (*sensu lato*, since this name was originally given only to the part which can be seen by tourists from the famous viewpoint of Montanvers) may be divided into three parts:

A broad accumulation zone, known as *Glacier du Géant* and *Vallée Blanche*.

A large ice fall, which is situated just below the firn line in normal years, and is known as *Séracs du Géant*. This is where Forbes' bands are formed. Almost all the studies made by Laboratoire de Glaciologie on this area are still unpublished.

A winding valley glacier about 8 km long (Fig. 1), the only part to be studied in this article.

The bedrock topography of this valley glacier was completely determined by seismic exploration in 1949 (Süsstrunk, 1951), 1960 (Vallon, 1961), and 1965-66 (Gluck, 1967). Some drillings to the bedrock have also been made (Reynaud and Cordouan, 1962). A map and cross-sections at the studied cross-profiles are given in Figure 2.



Fig. 1. Aerial view of Mer de Glace in 1958 (photograph: copyright Institut Géographique National, Paris, 1958).

As early as 1891, Joseph Vallot marked five cross-profiles on the lower 2.5 km of Mer de Glace with painted stones and surveyed yearly their position until 1900 (Vallot, 1900). Although this technique was primitive, since all the field data are reported, we may pick up the maximum velocities at each profile  $u_m$ , and we are sure that each period of enhanced velocities around the summer solstice is completely included between two successive surveys.

This work was restarted by Mougin (1934), from the Direction Générale des Eaux et Forêts, with the sole improvement of putting new painted stones along the same fixed cross-profiles each year. Unfortunately he does not give all the field data, only the mean velocities along a cross-profile, both ends being excluded. Thus these values are somewhat smaller than the maximum ones. Things were worse after he retired. Even in the years before and after World War II surveys were not done every year, and, on the minutes kept by the Eaux et Forêts, the precise dates of the surveys are missing, impeding the computation of accurate annual velocities from the displacements. We know maximum displacements at the cross-profiles, but only the general trend of the "annual velocities" plotted on our figures has any meaning.

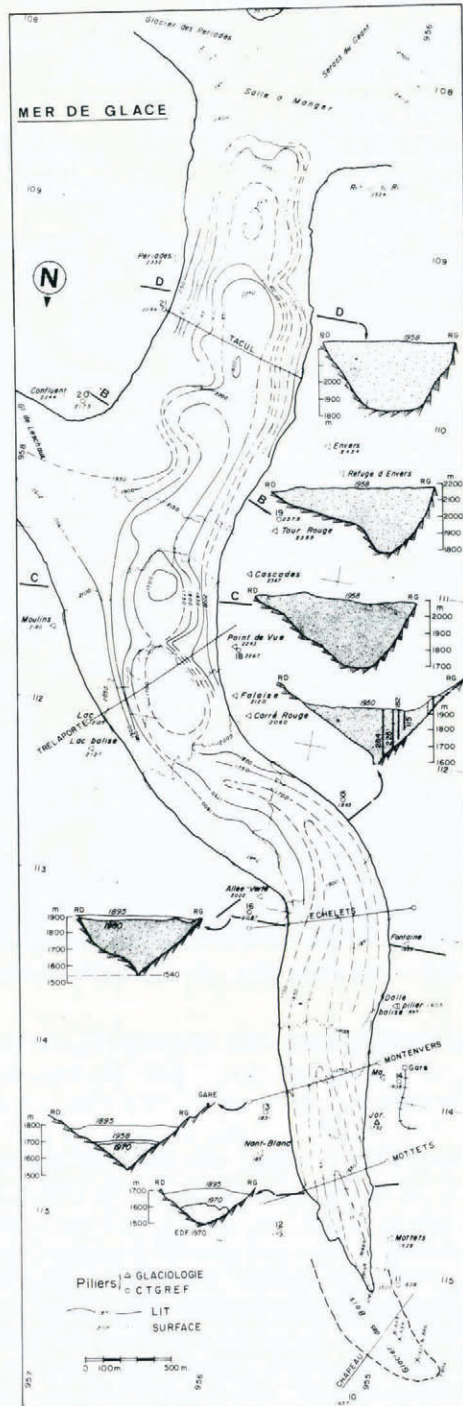

Fig. 2. Mer de Glace as it was in 1958 (plotted by Institut Geographique National) and its bedrock as determined by Electricité de France and Laboratoire de Glaciologie.

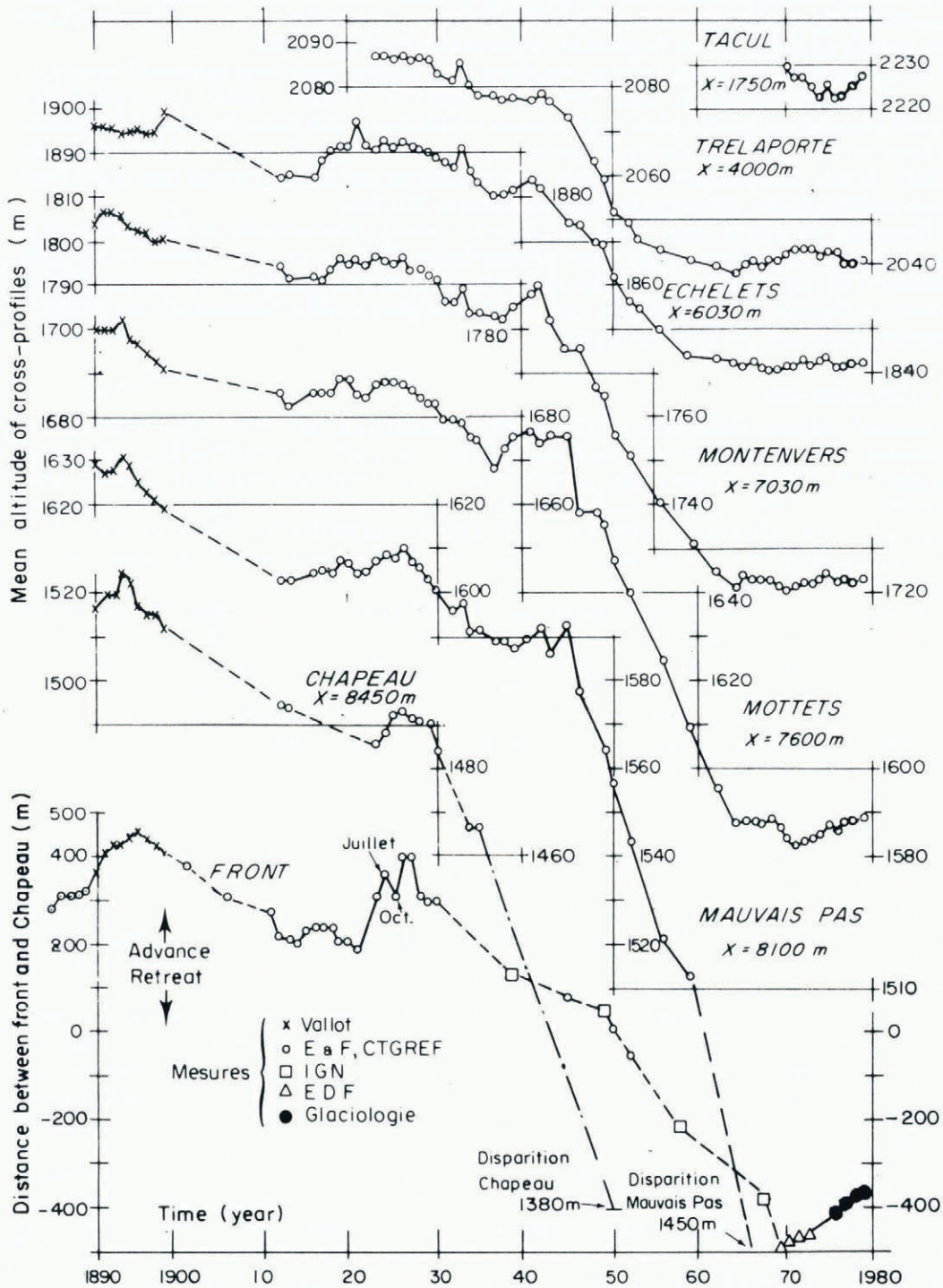

Fig. 3. Mean altitude at different cross-profiles. At the bottom: distance between snout and cross-profile Chapeau.

Moreover, because until 1962 all the surveys were made in July or August, the mean altitudes of the cross profiles are always several metres higher than those which would have been measured at the end of September, when it was done after 1962.

In recent times, mean altitudes at the fixed cross-profiles have been measured each year by the Centre Technique du Génie Rural et Forestier (CTGREF), under the responsibility of chief engineer de Crécy. Since 1966 a series of ablation stakes along the axis of the glacier has been surveyed at least once each year around 1 October by Laboratoire de Glaciologie du CNRS. A very accurate geodetic net has been established around the glacier, and all the fixed points used by former observers have been linked to this net.

Frequent surveys in some years has shown a strong enhancement of the velocities in June–July, which is of the same order of magnitude all along the 5 km where it has been measured. In this article we shall deal only with mean annual velocities. The mean velocity between 1 October (or mid-summer before 1962) of year  $t$  and 1 October of year  $(t+1)$  is plotted against year  $(t+1)$  in our figures.

### 3.2. *The secular trend*

Annual balances have been published by Reynaud ([1978]). The general pattern of variations of level, together with variations of the snout, are given in Figure 3. The most prominent feature is an important and continuous lowering between 1941–42 and 1964: 40 m at cross-profiles Trélaporte and Echelets (see Fig. 2 for locations), 68 m at Montenvers, 89 m at Mottets. After the fast retreat which ended the Little Ice Age, between about 1885 and 1941, and again between 1964 and today, the profiles have been fluctuating around apparently steady values.

In Figure 4 cumulative balances are given for Grosser Aletschgletscher, 100 km to the north-east and for Glacier de Sarnes, 100 km to the south-west. Owing to a very good correlation between annual balances at Sarnes and simple meteorological data recorded at the Lyon airport, Martin ([1978]) has been able to reconstruct past balances since 1882, which are also given in the figure. The general trend is a decreasing one, with an acceleration between 1941 and 1964. This enhanced rate of decrease has alone been effective in lowering Mer de Glace, and this occurred without any lag.

### 3.3. *Changes in the velocities*

Annual velocities measured by Laboratoire de Glaciologie between 1964 and 1973 are given on Figure 5. Down-stream of the first minimum ( $x = 2$  to 2.5 km), which corresponds to an overdeepening where the valley glacier is thickest (400 m in the middle) and broadest (near 1 000 m), *all velocity fluctuations are in phase over 5 km, and of the same order*. Solid lines on Figure 5 correspond to the budget years which were the highest (1970–71) and the lowest (1967–68) during the period of observation.

This behaviour also existed in the time of J. Vallot, when the glacier tongue was much thicker. This is apparent in Figure 6, where his data are plotted versus distance  $x$ , together with the velocities measured in 1970–71. A “normal” velocity was measured between 1895 and 1898. It does not decrease down-stream as rapidly as in recent times, because the snout was then more distant. During the three budget years ending in 1892–93–94, the velocity increased everywhere by 28–30 m per year.

All velocities measured at cross-profiles since 1913 are given at the bottom of Figure 7. The mean levels are plotted above, with a different scale for the period of continuous fast lowering. At cross-profiles Trélaporte and Echelets the velocities were almost the same in 1968–73 as in 1935–38, although the glacier surface had lowered by about 40 m during this interval. At cross-profile Mottets, almost the same annual velocity was measured in 1949–52 and 1971, in spite of a lowering of the surface by 76 m. An increased surface slope cannot have



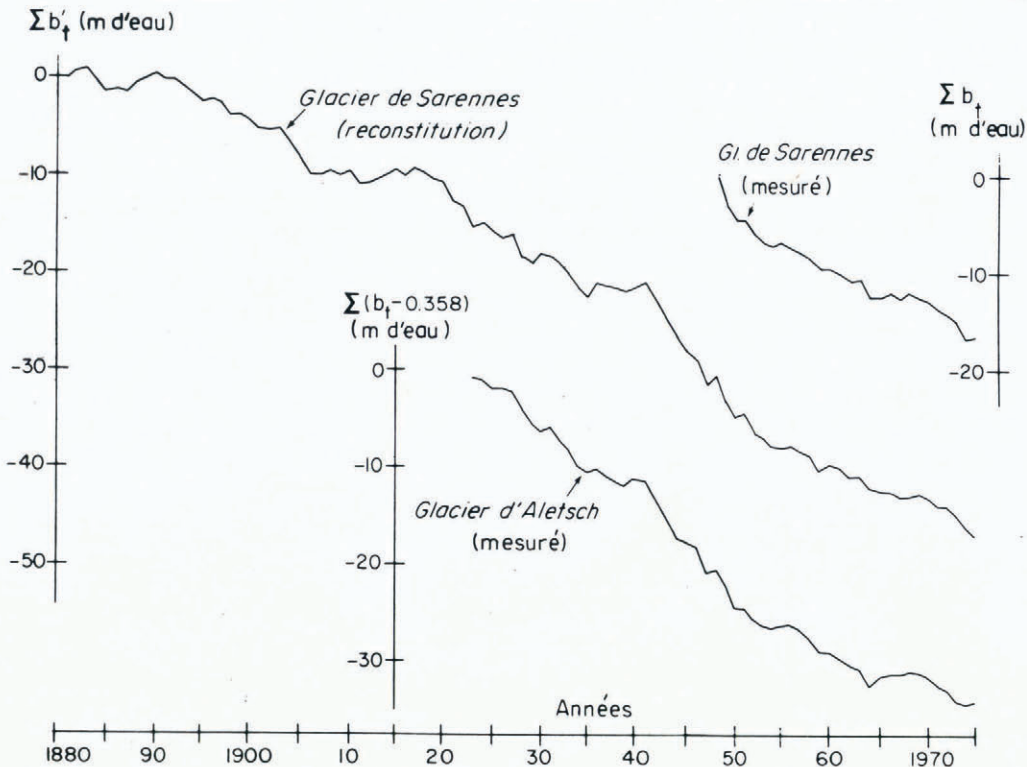

Fig. 4. Cumulative balances at Grosser Aletschgletscher (100 km to the north-east) and Glacier de Sarennes (100 km to the south-west). Balances at Glacier de Sarennes since 1882 have been reconstructed from meteorological data by S. Martin ([1978]). After 1949 these calculated values may be compared with the measured ones, top right (the reference levels are not the same).

compensated for the thinning of the glacier. In particular since Trélaporte and Echelets lowered by a similar amount, the surface slope there has not changed. Obviously the initial assumption of Weertman and Nye that velocity is a function of thickness and surface slope at the given cross-section is unsound.

Since any peak in the velocities for a single year before 1962 is dubious, only two maxima for the velocities can be identified confidently from Figure 7: around 1918–23 and in 1971. The latter, the only one which has been very accurately surveyed, was the same year, 1971, at all the profiles.

This velocity maximum in 1971 corresponds to maximum levels at the upper profiles, while at Montenvers the surface was just beginning to rise, and at Mottets it was at its minimum. Thus it seems that, in the more or less steady situation subsequent to 1964 at least, the upper part of the valley glacier controls the velocity several kilometres down-stream. Our comments on Figure 5 lead to the idea that it is the area around  $x = 2\ 500$  m which controls the velocity down-stream.

### 3.4. Travelling waves

Faint waves (for the surface levels only, not for the velocities) have travelled down Mer de Glace in 1891–96, 1921–27, 1941–45, and 1970–78, following some years with favourable balances. Since these waves are only 4–5 m high, levels measured in July or August cannot lead to unquestionable conclusions, but the existence of travelling waves and their cause has been proved by Martin ([1978]) as follows.

First he explains how waves may form, in spite of balance deviations  $b_1$  being more or less uniform over all the glacier. It is the same process (extended to a larger span of time) as the one which forms wave ogives at the foot of an ice fall (Nye, 1958). In the areas where a glacier is fast and shallow, it is more affected by balance deviations. On Mer de Glace these faint and broad travelling waves and annual wave ogives are formed in the same area, namely in the Séracs du Géant zone (where we have arbitrarily situated the origin of abscissae  $x$ ).

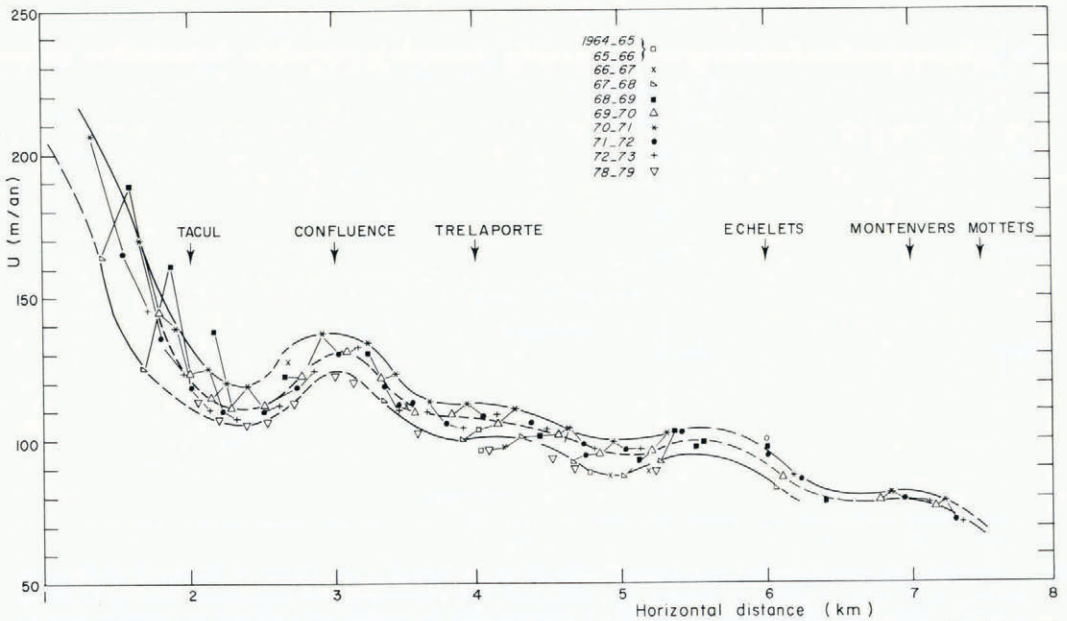

Fig. 5. Annual surface movements (from 1 October to 30 September) in the middle of Mer de Glace, as measured by Laboratoire de Glaciologie. Origin of horizontal distances along the centre line is taken in the glacier fall. Each annual movement is plotted at the corresponding final location. Solid lines correspond to years 1970/71 and 1978/79. Down-stream of  $x = 2.5$  km, the annual velocities were the highest and the lowest in these years. Up-stream of  $x = 2.5$  km this was not so. Thus we conclude that the region around  $x = 2.5$  km is controlling the velocity down-stream.

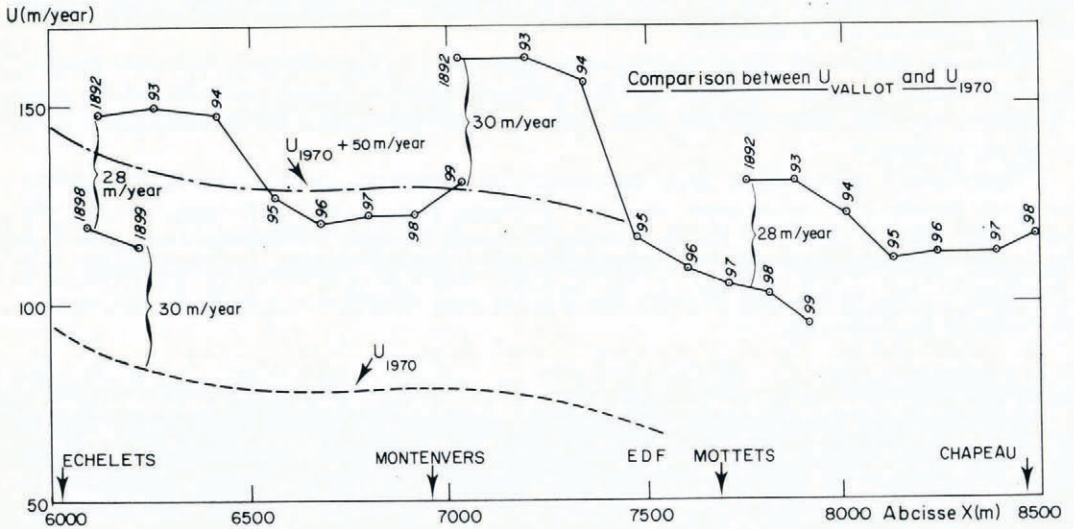

Fig. 6. Surface velocities along the centre line in the time of J. Vallot to be compared with the same in 1970.

Martin has sought correlations between levels at a given cross-profile and deviations from mean balance  $b_1(t)$  during preceding years. The correlation is highly significant for a particular lag. For cross-profiles of Trélaporte ( $x = 4\ 000\text{ m}$ ), Echelets ( $x = 6\ 030\text{ m}$ ), Montenvers ( $x = 7\ 030\text{ m}$ ), and Mottets ( $x = 7\ 600\text{ m}$ ), these lags are respectively 3, 8–9, 10, and 11 years. This agrees quite well with a wave travelling at 450 m/year between Trélaporte and Mottets. Up-stream of Trélaporte the wave velocity should be faster, as is the ice velocity.

In order to make these waves clearly noticeable, cross-profile levels should be corrected to allow for the deviation  $b_1$  of the balance during the corresponding year. The result is plotted in Figure 7 (thick line). Unquestionably a wave has travelled down-stream between Trélaporte and Mottets at a fairly uniform velocity of 500 m per year, while the ice velocity (at the surface and the middle of the glacier, denoted  $u_m$ ) lowers from about 105 to about 55 m per year.

The wave of 1891–95 was analysed in Lliboutry (1958). (Reproduced in Lliboutry, 1964–65, Tom. 2, p. 629 and 639–40.) Its velocity was estimated to be 800 m/year. A more precise estimation by Reynaud ([1978]) is 725 m/year. The velocity along the valley axis increased in the course of these years from about 125 to about 155 m/year.

Mougin (1934) asserted that waves travelling up-stream or standing waves may be seen in some years. His interpretation is very subjective. Nevertheless we shall comment on the intriguing synchronous rise by 4–5 m in 1933 which is seen in Figure 7 for Trélaporte, Echelets, and Montenvers (but not for Mottets). There is also a peak in the “annual” displacements in 1933–34. The date of the 1933 survey has, exceptionally, been recorded: 20 July 1933. A tentative explanation may be that in 1931, 1932, and 1934 the surveys were made in late September. A more plausible explanation is that serious mistakes were made in 1933.

To compare the measured velocities of travelling waves with the corrected value  $c_0 - D_0' - (D_0/Y_0) Y_0'$ , the diffusion coefficient  $D_0(x)$  given by Equation (4) must be estimated.

In the area just down-stream of cross-profile Tacul, where the glacier is thickest and sliding negligible,  $u_m \approx 120\text{ m/year}$ . Table I gives, for  $W = 1$ ,  $\bar{u}/u_m = 0.674$ . Then  $\bar{u} \approx 80\text{ m/year}$  and the discharge is about  $80 \times \frac{1}{3} \times 800 \times 400 = 17 \times 10^6\text{ m}^3$  of ice per year. The slope of the surface being 0.08:

$$D_0 = \frac{1}{Y_0} \frac{\partial q}{\partial \alpha} = \frac{n}{Y_0} \frac{q}{\alpha} = 8 \times 10^5\text{ m}^2\text{ year}^{-1}. \tag{10}$$

Now this value decreases with  $q$  down-stream, to vanish at the front, about 8 km down-stream. Thus a mean value of  $D_0'(x)$  should be about  $-100\text{ m/year}$ . Also the surface width  $Y_0$  decreases from 800 m to zero in 8 km. Thus a mean value of  $Y_0'(x)$  is  $-0.1$  and  $(D_0/Y_0) Y_0'(x) \approx -100\text{ m/year}$ . Thus the theoretical velocity of kinematic waves  $c_0$  of 2.0–2.6 times  $u_m$ , should be increased by about 200 m/year. The agreement with the observed velocity of travelling waves, 450–500 m/year seems not too bad.

Nevertheless the classical theory fails completely for the velocity fluctuations, and compels us to set up a new theory.

#### 4. THE VALLEY GLACIER AS A GLOBAL SYSTEM

##### 4.1. The local friction law

The inadequacy of Weertman’s friction law when sliding gets important is proved by three facts.

1. There is an important rise in the velocities around the summer solstice, when the rate of snow melting is a maximum. Heavy rain during summer may have the same effect. Thus the head in subglacial waterways must enter as another independent parameter into the friction law.

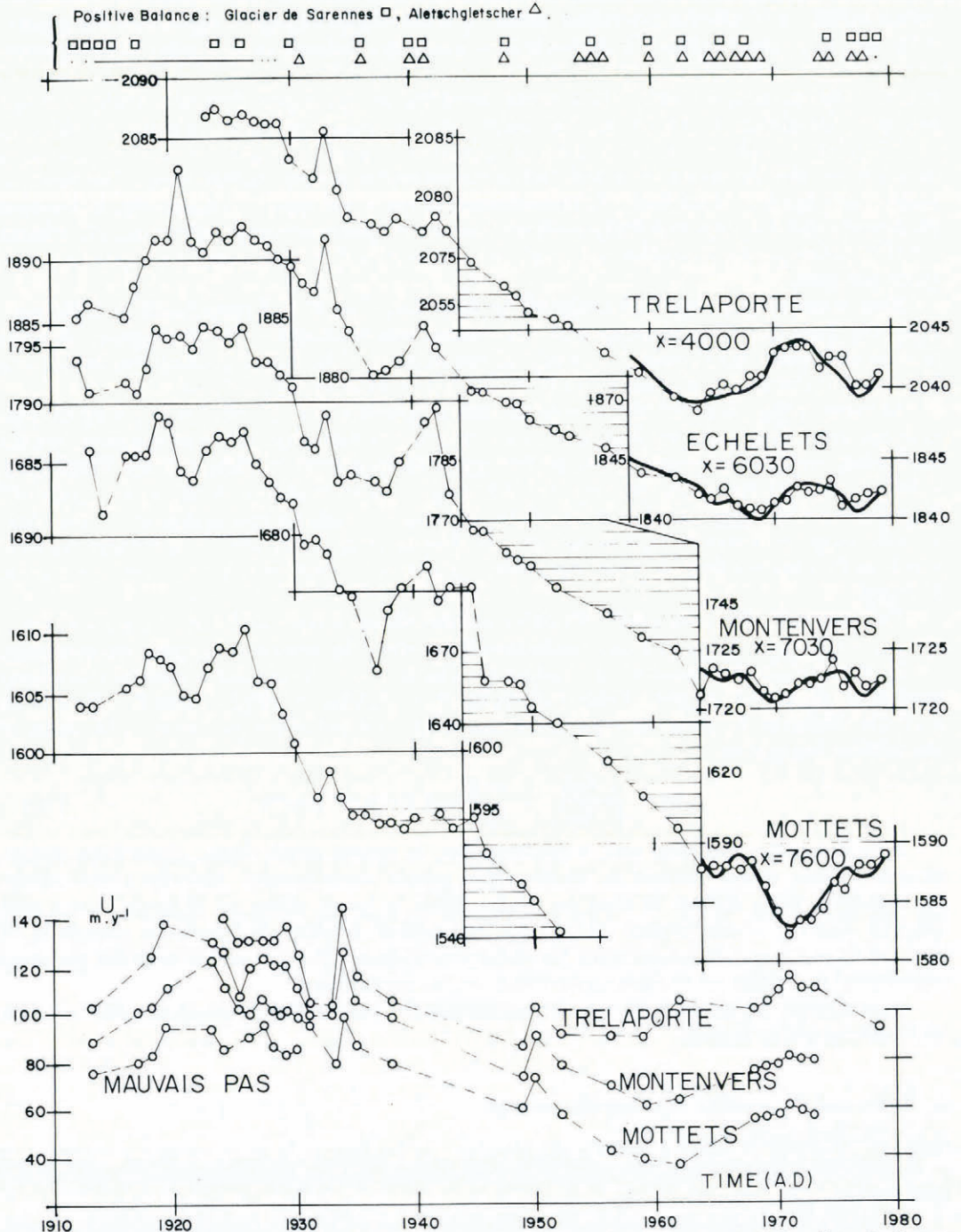

Fig. 7. Top: Variation of the mean altitude of the surface at cross-profiles (notice the change of scale by a factor five between the forties and the sixties). Thick curves represent corrected values, where the deviation from mean of the balance the same year has been subtracted. Bottom: Annual velocities (maximum over a cross-section, a little less for years 1912-30, and with a random centred error for years 1933-62 (see text)).

2. Even for glaciers which are flowing very fast (several kilometres per year for the tidal outlets of big ice sheets for instance), the friction always remains of the order of one bar. Precise calculations in the case of Séracs du Géant, where the velocity rises up to about 1 000 m per year, give a local friction varying in a random way in the range 0–2.0 bar (Reynaud, unpublished). This friction is the same as for slow temperate glaciers where sliding is only a few metres per year. According to Weertman’s law it should be one order of magnitude larger.

3. As said above, a lowering of the surface by 40 to 90 m, which changes consistently the bottom shear stress, may not change the sliding velocity at all.

As reported elsewhere (Lliboutry, 1979), these facts may be explained by considering ice–bedrock separation. The trouble is that the friction law so found is very dependent upon the geometrical model which is adopted for the microrelief of the bedrock. With bumps of similar length and random heights we can adopt as a first approximation a solid friction law of the form

$$\tau_b = f(p_1 - p) \tag{11}$$

where  $p_1$  is the mean normal pressure of ice against bedrock and  $p$  the pressure in the inter-connected and more or less infilled cavities in the lee of the bumps. This law has allowed one of us to explain the internal velocities measured on Saskatchewan Glacier (Reynaud, 1973).

To adopt this solid friction law raises two problems. First we need a new theory to estimate the pressure  $p$ . We assume that, owing to the many scratches and joints in the bedrock, the piezometric level is the same in all the cavities as in the neighbouring subglacial waterway. The steady pressure in such a waterway has been calculated by Röthlisberger (1972). We shall come back to this theory in some future article. Let us say for the moment that in most cases the loss of Newtonian energy by running water exceeds by far the energy which is needed to melt ice and keep the waterway open. With the exception of the beginning of the melting season (when waterways are totally filled with water and the water head rises considerably), subglacial streams are at atmospheric pressure. Then (not including atmospheric pressure, which affects  $p_1$  and  $p$  equally) we may put  $p \approx 0$ .

A noteworthy exception is in overdeepened areas. There during most of the year the subglacial water pressure is more or less the same as if there was no glacier and the overdeepening was filled by a lake.

The second problem is to explain how the sliding velocity is determined. Of course we can introduce a more elaborate friction law, with some small term in  $u_b^{1/m}$  produced by independent knobs (Lliboutry, 1979). Nevertheless field data for Mer de Glace lead to the conclusion that it is the overdeepened area around  $x = 2\,500$  m which should be the main controlling zone. There a straight and thick portion of the glacier comes up against a subglacial transverse shoulder, and large deviatoric stresses are needed to overcome this obstacle.

#### 4.2. *Zones which may control the sliding velocity*

In the rough analysis mentioned above of a travelling wave observed by Vallot, the change of direction of the valley just up-stream of cross-section Echelets was thought to be the main controlling factor. At that time the subglacial shoulder which narrows the valley just before the confluence with Glacier de Leschaux was still unknown.

To consider only cylindrical channels in glacier theory may lead to false ideas. Within a cylinder (and more generally within channels formed by helices with the same axis and the same screw-path), plug flow is possible. In actual valley glaciers it is not: the body of the glacier needs to deform to allow any flow. Then, for a given discharge and over a given length, more Newtonian energy needs to be dissipated than within a cylindrical channel. The mean slope of the surface therefore needs to be larger. Conversely, for a given surface slope, velocities resulting from body deformation which may be calculated using the cylindrical model are larger than the actual ones.

Around the Tacul cross-section, for a length of about 1 600 m, the glacier is more or less cylindrical with a mean slope  $\tan \alpha \approx 0.08$ ,  $h \approx 410$  m, and  $W \approx 0.9-1.2$ . According to Table I, since  $A \approx 0.2-0.3 \text{ bar}^{-3} \text{ year}^{-1}$ , the maximum velocity  $u_m$  without sliding should be 40-70 m/year. Now the observed velocity in the middle of the glacier decreases over these 1 600 m from 230 to 110 m/year. Thus sliding is very important there. Just after the shoulder, the velocity  $u_m$  increases a little, to 130 m/year (transverse crevasses are formed), but the maximum thickness remains close to 400 m. It is only the surface slope which increases markedly, up to 0.13. If the calculations made for a very long cylindrical channel were valid for such a short length, no sliding would be found. The considerations above lead to the contrary conclusion.

Thus most of the movement of this valley glacier comes from sliding everywhere, a fact which allows longitudinal deviatoric stresses to be transmitted over long distances. Nevertheless the deviatoric stresses which are needed to overcome the subglacial shoulder must be consistently larger. This fact makes the glacier movement down-stream of the shoulder independent of any longitudinal stress up-stream. Whatever may be the discharge of ice pouring down the glacier fall, two kilometres down-stream, at the subglacial shoulder, the discharge is regulated. The five kilometres of glacier down-stream of this controlling zone may be pulled or pushed from the controlling zone if necessary.

More generally, in any valley glacier where sliding predominates, regions where the deformation of the body of the glacier is important should be controlling zones, and between two successive controlling zones the glacier should react as a whole. This point of view is a direct consequence of assuming a solid friction law.

#### 4.3. Perturbation equation with a new model for the sliding velocities

The mean velocity at a cross-section is assumed to be the sum of a deformation velocity  $\bar{u}$  and a sliding velocity  $v$  which is more or less the same over the whole of the given cross-section. The deformation velocity is always a function of the maximum thickness  $h$  in the cross-profile and the "local" surface slope  $\alpha = -\partial h/\partial x$ , but the fluctuations with time of the sliding velocity are almost independent of the fluctuations of these two local variables. A simple linear model is thus assumed:

$$v = v_0(x) + v_1(t). \quad (12)$$

The mean value with time (the mathematical expectancy) of perturbation  $v_1(t)$  is zero. The discharge at cross-section  $x$  and time  $t$  is then:

$$q(x, t) = S(x, t)[\bar{u}(h, \alpha) + v_0(x) + v_1(t)]. \quad (13)$$

For steady values, mass conservation gives:

$$\frac{d}{dx} [S_0(\bar{u}_0 + v_0)] = b_0 \gamma_0. \quad (14)$$

If  $\bar{u}_0(h, \alpha)$  was computable for a realistic model of the glacier, this equation would give  $v_0(x)$ , starting from the front and putting the field values of  $b_0$ ,  $\gamma_0$ , and  $S_0$ . The whole problem down-stream of the ice fall (which is the longitudinal glacier profile able to evacuate a given discharge) is mechanically determined, taking into account a solid friction law, but is a very difficult one. Let us say only that a uniform surface slope  $\tan \alpha = f$  is *not* the solution (it would be for a two-dimensional situation and an almost uniform, gently varying thickness).

Let us consider now small perturbations (subscript 1). Since  $S_1 = \gamma_0 h_1$ ,

$$q_1 = \gamma_0 c_d h_1 - \gamma_0 D_d \frac{\partial h_1}{\partial x} + v_0 \gamma_0 h_1 + S_0 v_1 \quad (15)$$

with

$$c_d = \frac{\partial(S\bar{u})}{\partial S} \Big|_0, \quad D_d = \frac{1}{\gamma_0} \frac{\partial(S\bar{u})}{\partial \alpha} \Big|_0. \quad (16)$$

The subscript d reminds us that  $S\bar{u}$  is that part of the discharge which proceeds from body deformation only. Putting this value into Equation (1),

$$\frac{\partial h_1}{\partial t} = b_1 - \frac{S_0'}{\gamma_0} v_1 + \left( e_0 - c_d' - \frac{c_d}{\gamma_0} \gamma_0' - v_0' - \frac{v_0}{\gamma_0} \gamma_0' \right) h_1 - \left( c_d + v_0 - D_d' - \frac{D_d}{\gamma_0} \gamma_0' \right) \frac{\partial h_1}{\partial x} + D_d \frac{\partial^2 h_1}{\partial x^2}, \quad (17)$$

which may be compared with the classical perturbation Equation (5).

1. A new term  $(S_0'/\gamma_0) v_1$  is introduced. At the foot of ice fall Séracs du Géant  $S_0'/\gamma_0$  should be as large as 0.3 and, since  $v_1(t)$  is of the order of 10 m/year, this term is not at all negligible.

2. Since  $v_0$  is no longer a function of  $h$ , a term  $(S_0/\gamma_0) \partial v_0/\partial h$  has disappeared in the velocity of kinematic waves. Also  $D_d$  is smaller than the former value  $D_0$ . Thus, at first sight, the new theory leads to lower velocities for travelling waves. Measured velocities are however rather higher than those calculated with the old theory.

Nevertheless the calculation of  $\partial q/\partial h$  made in Section 2.2 may be questioned, since in the new theory strong deviatoric stresses are transmitted from the controlling zone. We may consider the two-dimensional case only, and speculate that the complete mechanical treatment of the body of the glacier leads approximately to a bottom friction

$$\tau_b = \rho gh \sin \alpha - \sigma \quad (18)$$

where  $\sigma$ , caused by the controlling zone, is more or less independent of  $h$ . We assume also that the discharge per unit width due to deformation keeps the classical value

$$q_d = h\bar{u} = B\tau_b^n h^2/(n+2). \quad (19)$$

Then  $\partial \tau_b/\partial h = (\tau_b + \sigma)/h$  and

$$c_d = \frac{\partial q_d}{\partial h} = \bar{u} \left[ 2 + n \frac{\tau_b + \sigma}{\tau_b} \right], \quad (20)$$

which may be considerably higher than the classical value of  $\bar{u}(2+n)$ .

Of course this is not a proof. It is only a heuristic argument for being optimistic about the results of very difficult calculations to be done. On the other hand, the initial linear model given by Equation (12) is checked by the study of Forbes' bands.

## 5. PAST VELOCITIES DEDUCED FROM FORBES' BANDS

### 5.1. Formation of Forbes' bands

Since several kinds of banding may be seen on glaciers, a precise description of the one which affords information on past velocities seems necessary. The formation of Forbes' bands at the foot of Séracs du Géant has been thoroughly described and explained by Vallon (unpublished).

At the top of the ice fall (2 700 m a.s.l., that is just below the equilibrium line) the velocity is 850–1 000 m/year. Vertical faults transform the slices of glacier between transverse crevasses into steps. About eight steps per year are so formed. The whole is completely upset while it descends to 2 450 m in 470 m (measured along the slope), but still some faint furrows coming from the primitive crevasses may be seen there. The velocity has then lowered to about 290 m/year. There, a short shelf known as “la salle à manger” is found. Next there is a smaller steep slope between 2 400 and 2 310 m with transverse crevasses (the velocity has increased to 330 m/year).

Five to six large waves (the so-called wave ogives) can be seen below the lower crevassed area. They are formed annually, by the process explained by Nye (1958). The first visible bump on summer of year  $(t+1)$  corresponds to ice which has crossed the upper steepest 470 m during the accumulation season  $(t-1)$  to  $t$ . The second one is the highest (10 m);

successive heights are: 7, 3, 1.5 m. Distances from each other correspond to the measured surface velocities (230 to 150 m/year).

The fast damping of these wave ogives agrees well with the low viscosity of surface ice, owing to a large compressive strain-rate ( $\partial u/\partial x = -0.18 \text{ year}^{-1}$ ). (This point has been missed by Lick (1970).) The difference in ablation between bumps and furrows (about 0.4 m/year) is a secondary factor only.

Although dust collects in the furrows at the beginning of the melting season, this is not the origin of the dark bands, which develop progressively down-stream. Dark bands correspond to less bubbly and more dusty ice which forms during summer in the big ice fall. Thanks to crevasses, regelation blue ice and dust penetrate about two-thirds of the glacier thickness. Thus, although melt water and summer rain wash the surface continually, dark and white bands retain considerable contrast down-stream.

Lastly the first dark bands appear on the bumps, and not in the furrows between, because the larger ablation on the southward side has moved the bumps relative to ice by several metres per year.

To summarize, Forbes' bands and wave ogives, although both formed annually at the foot of an ice fall, are quite distinct phenomena. Since Forbes' bands do not move relative to the ice, they must retain the record of velocity fluctuations as long as all the polluted, blue ice has not melted, that is for about 45 years in the case of Mer de Glace.

### 5.2. Data analysis

The linear model given by Equation (12) is adopted for the sliding velocity, and any fluctuation of the deformation velocity caused by travelling waves is neglected. The maximum velocity measured at surface, on the glacier axis, is

$$u_m(x, t) = U(x) + v_1(t). \quad (21)$$

For  $U(x)$ , the velocities measured in 1969–70 have been adopted. At some abscissa  $x$ , where two bands formed during years  $t-1$  and  $t$  are found, the distance between these two bands is

$$e(t) = U(x) + v_1(t) - v_1(t-1). \quad (22)$$

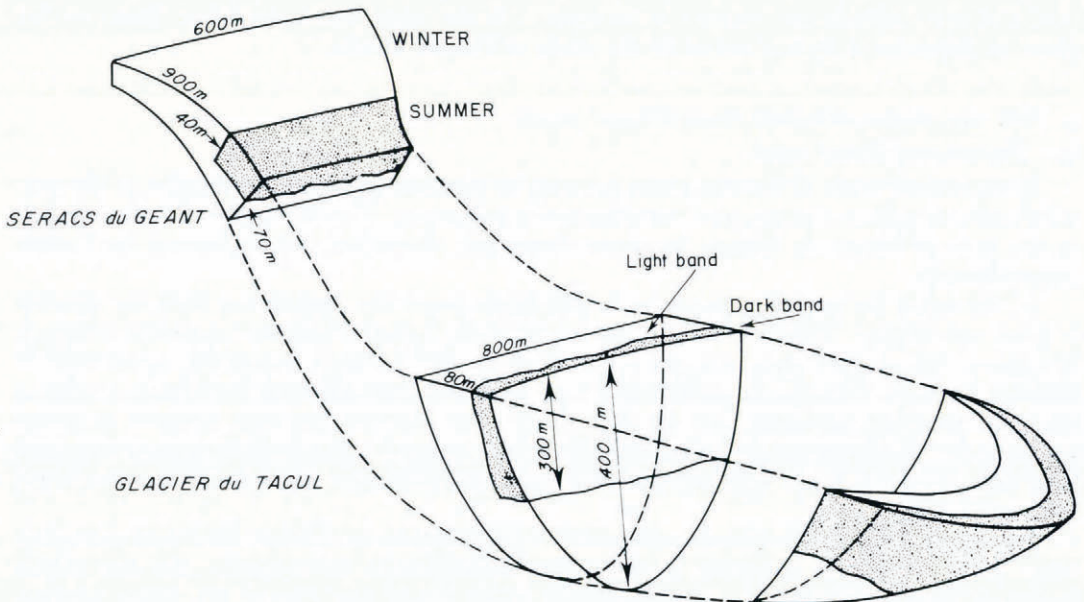

Fig. 8. Sketch showing how Forbes bands are formed and tilt down-stream.



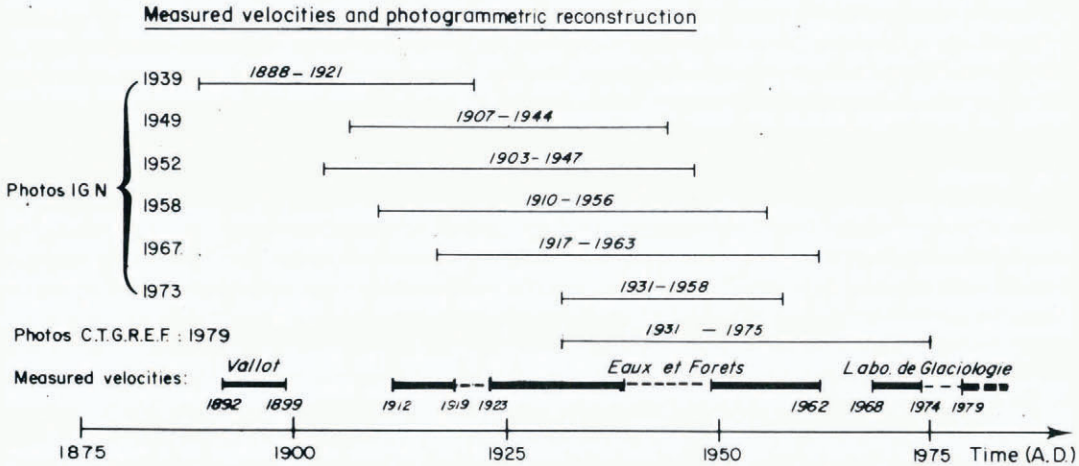

Fig. 9. Intervals of time for which velocity fluctuation  $V_I(t)$  may be reconstructed (top) and during which they were actually measured (bottom).

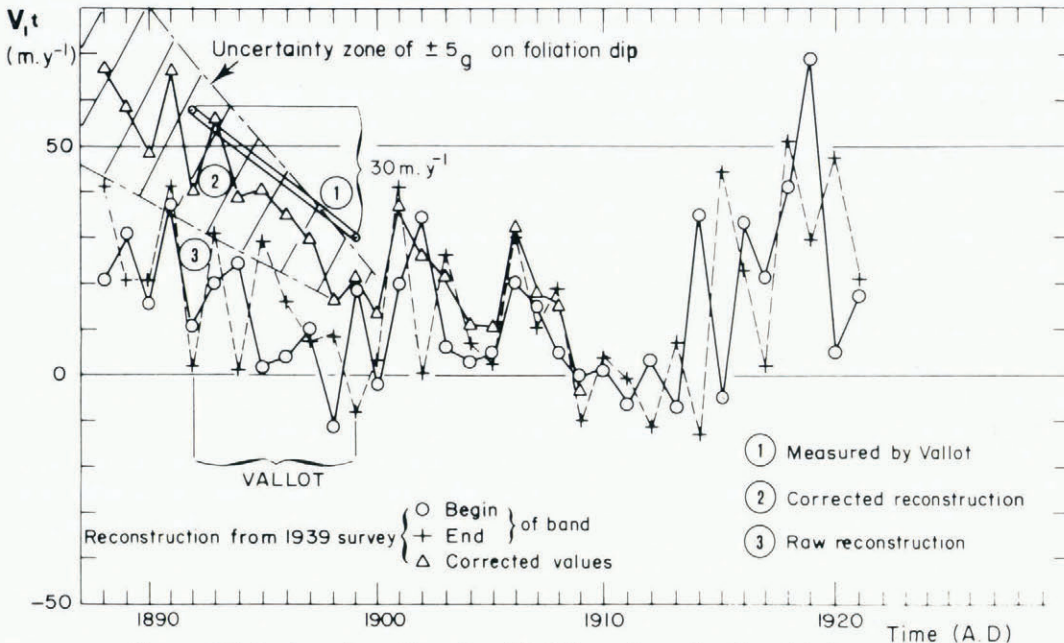

Fig. 10. Velocity fluctuations  $v_I(t)$  at time of J. Vallot as drawn from the aerial pictures of 1939.

Thus, given a continuous sequence of  $e(t)$ , the successive  $v_I(t)$  can be deduced.

For more accuracy both limits of each dark band have been plotted separately on the aerial pictures.

Nevertheless a correction must be made because the successive slices of blue, dusty, and white, clean ice, which were vertical at the start, tilt down-stream, especially when crossing two steeper and crevassed areas (Fig. 8). The reasoning above would be valid only for a null balance. This correction is feasible since the dip of foliation has been measured by Vallon (unpublished), and the negative balances are known.

Six aerial surveys made in 1939, 1949, 1952, 1958, 1967, and 1973 by the Institut Géographique National have been used, as well as a seventh made by CTGREF in 1979. The span of time to which they give access, and the years with velocity measurements on the field allowing a check of the method, are given in Figure 9. The aerial pictures were plotted using a Stereotope made by Zeiss-Oberkochen.

### 5.3. Results

Among the seven series of reconstructed velocities, the oldest and the most recent can be checked by independent field measurements. Fluctuations in velocity  $v_1(t)$  drawn from the oldest picture are plotted on Figure 10 together with Vallot's measured field values. The raw reconstruction was far from "ground truth" but after taking tilt into account the agreement becomes acceptable.

All the seven reconstructed  $v_1(t)$  are plotted in Figure 11. Each is a mean between the values deduced from the up-stream and from the down-stream limits of dark bands, corrected for tilt.

Scattering of results is higher than stereoscopic error (about 10 m only), as a consequence of two factors. First, a band is not as regular as usually sketched. The stereoscopic examination shows breaks and excrescences in some bands. The volume of dirty blue ice would be expected to have an irregular shape. Since Forbes' bands are sections of this volume at different levels, scatter in their width ensues. Second, our very simple linear model ignores trends coming from important changes in the glacier volume.

In spite of this noise, Figure 11 can be considered as a good check of our theory, since series  $v_1(t)$  drawn from aerial pictures on quite different years remains within a narrow winding band. Information on  $v_1(t)$  stored in each band has not been lost between 1939 and 1967, although each band moved about 2.5 km between these years.

In particular it appears that velocities did not have a maximum between their high values in 1918 and 1923. There were rather two distinct maxima, in 1918 (or 1919) and 1923 (or 1922). The peak of 1950 seems also to have really existed, but there was no peak in 1934.

## 6. CONCLUSION: SUGGESTIONS FOR FUTURE WORK

It has been shown that fluctuations of velocity in the past may be inferred from Forbes' bands. In areas where annual balances are not very negative, and thus the tilt correction is small, past changes in velocity may then be assessed from aerial coverage.

This success comes from the fact that fluctuations in sliding velocity with time are the same over a long distance (about 20 times the glacier thickness in our case). Sliding velocities are determined by some controlling area where the body of the glacier must deform strongly.

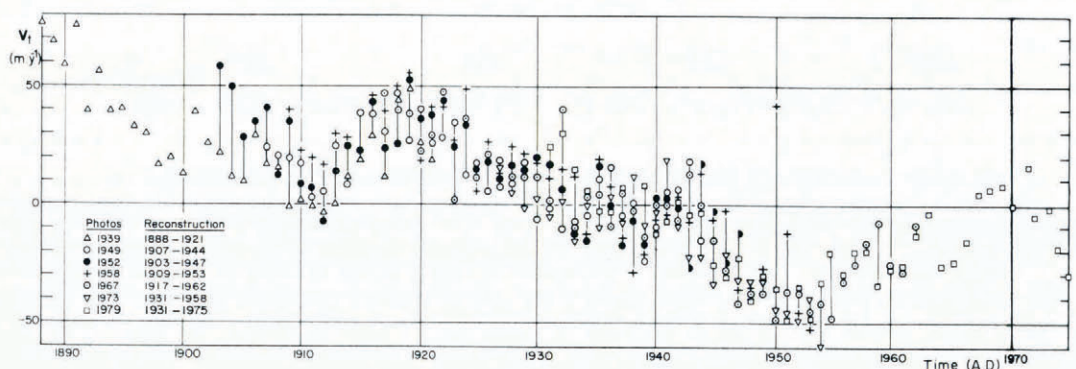

Fig. 11. Velocity fluctuations as drawn from Forbes' bands.

From such an area, a longitudinal deviatoric stress (compressive upwards, extensive downwards) propagates over a long distance. The mean bottom drag, which obeys roughly a solid-friction law and is independent of the velocity, should then be less than its classical value  $\rho g R \sin \alpha$  (where  $R$  is the hydraulic radius and  $\tan \alpha$  the surface slope averaged over a long distance). Bindschadler and others (1977), for instance, say that on Variegated Glacier velocities are well correlated with surface slope averaged over about ten times the glacier thickness, not with local surface slopes. Nevertheless they ignore body stresses resulting from the fact that the glacier bed may not be cylindrical.

This difference should not be forgotten in any attempt to infer a sliding law from field data.

In "global dynamics", each glacier is a special case. For a given cross-section its discharge is not given by a universal law  $q(h, \alpha)$ . Detailed studies such as this one should be done on several other valley glaciers, and in every case:

- (a) controlling areas must be sought. The best way seems to be to correlate fluctuations in velocity and surface elevations at many cross-sections, and see where the correlation is best;
- (b) if the bedrock is well known, longitudinal stresses produced in the controlling area by body deformation might be estimated. This is a difficult three-dimensional problem in non-linear viscosity.

In our opinion this work should be done before tackling the ultimate problem: "given a valley and a spatial distribution of annual balances, what are the profile and the velocities in the steady state?". As already said, in the case of Mer de Glace it seems that minor fluctuations around a steady state have existed since 1964, and minor fluctuations around another steady state existed between 1885 and 1941. Another steady state with the glacier pouring off into the Chamonix valley, existed during the Little Ice Age. Variations in balance, as shown in Figure 4, have a much more regular secular trend. There seem to be several discontinuous stable positions for the front, and, from time to time, a jump from one stable position to another occurs. Any explanation of this fact should take into account the possible existence of several potential controlling areas along the valley.

These intriguing and still open questions make the monitoring of travelling waves of secondary importance. Nevertheless a better assessment of the different parameters entering into Equation (17) should be undertaken. From a correct field value of  $c_d$ , the longitudinal stress  $\sigma$  can then be estimated using Equation (20).

#### ACKNOWLEDGEMENTS

Field work over the last 20 years has been done with the aid of many people from the staff of Laboratoire de Glaciologie and some post-graduate students. Let us recall the memory of the late Roland Vivet and the late Yves Morin, both guides and topographers, lost in mountaineering accidents. Thanks are specially given to the indefatigable C. Carle for his topographical work, and to F. Gillet for managing the logistics. We had the benefit of fruitful discussions with Dr M. Vallon, and of unpublished data from Electricité de France and Centre Technique du Génie Rural et Forestier.

*MS. received 4 January 1980 and in revised form 18 February 1980*

#### REFERENCES

- Baussart, M., and others. 1965. Étude photogrammétrique des glaciers du Massif du Mont-Blanc, par M. Baussart, M. Carboneil, et C. Cazabat. *Annales de Géophysique*, Vol. 21, No. 3, p. 450-61.
- Bindschadler, R. A., and others. 1977. Geometry and dynamics of a surge-type glacier, by R. [A.] Bindschadler, W. D. Harrison, C. F. Raymond, and R. Crosson. *Journal of Glaciology*, Vol. 18, No. 79, p. 181-94.
- Duval, P. 1981. Creep and fabrics of polycrystalline ice under shear and compression. *Journal of Glaciology*, Vol. 27, No. 95, p. 129-40.

- Finsterwalder, S. 1907. Die Theorie der Gletscherschwankungen. *Zeitschrift für Gletscherkunde, für Eiszeitforschung und Geschichte des Klimas*, Bd. 2, Ht. 2, p. 81–103.
- Gluck, S. 1967. Détermination du lit rocheux sous la Mer de Glace par séismique-réflexion. *Comptes Rendus Hebdomadaires des Séances de l'Académie des Sciences (Paris)*, Sér. D, Tom. 264, No. 19, p. 2272–75.
- Lick, W. 1970. The propagation of disturbances on glaciers. *Journal of Geophysical Research*, Vol. 75, No. 12, p. 2189–97.
- Lighthill, M. J., and Whitham, G. B. 1955. On kinematic waves. *Proceedings of the Royal Society of London, Ser. A*, Vol. 229, No. 1178, p. 281–345.
- Lliboutry, L. A. 1958. La dynamique de la Mer de Glace et la vague de 1891–95 d'après les mesures de Joseph Vallot. *Union Géodésique et Géophysique Internationale. Association Internationale d'Hydrologie Scientifique. Symposium de Chamonix, 16–24 sept. 1958*, p. 125–38. (Publication No. 47 de l'Association Internationale d'Hydrologie Scientifique.)
- Lliboutry, L. A. 1964–65. *Traité de glaciologie*. Paris, Masson et Cie. 2 vols.
- Lliboutry, L. A. 1971. The glacier theory. *Advances in Hydrosceince*, Vol. 7, p. 81–167.
- Lliboutry, L. A. 1974. Multivariate statistical analysis of glacier annual balances. *Journal of Glaciology*, Vol. 13, No. 69, p. 371–92.
- Lliboutry, L. A. 1979. Local friction laws for glaciers: a critical review and new openings. *Journal of Glaciology*, Vol. 23, No. 89, p. 67–95.
- Marchi, L. de. 1911. La propagation des ondes dans les glaciers. *Zeitschrift für Gletscherkunde, für Eiszeitforschung und Geschichte des Klimas*, Bd. 5, Ht. 3, p. 207–11.
- Martin, S. [1978.] Analyse et reconstitution de la série des bilans annuels du Glacier de Sarennes, sa relation avec les fluctuations du niveau de trois glaciers du Massif du Mont-Blanc (Bossons, Argentière, Mer de Glace). *Zeitschrift für Gletscherkunde und Glazialgeologie*, Bd. 13, Ht. 1–2, 1977, p. 127–53.
- Meier, M. F. 1968. Calculations of slip of Nisqually Glacier on its bed: no simple relation of sliding velocity to shear stress. *Union de Géodésie et Géophysique Internationale. Association Internationale d'Hydrologie Scientifique. Assemblée générale de Berne, 25 sept.–7 oct. 1967. [Commission de Neiges et Glaces.] Rapports et discussions*, p. 49–57. (Publication No. 79 de l'Association Internationale d'Hydrologie Scientifique.)
- Meier, M. F., and others. 1974. Flow of Blue Glacier, Olympic Mountains, Washington, U.S.A., by M. F. Meier, W. B. Kamb, C. R. Allen, and R. P. Sharp. *Journal of Glaciology*, Vol. 13, No. 68, p. 187–212.
- Mougin, P. 1925. *Études glaciologiques. Tom. 5*. Paris, Direction générale des Eaux et Forêts, Service des Forces hydrauliques, Imprimerie Nationale.
- Mougin, P. 1934. *Études glaciologiques. Tom. 7*. Paris, Direction des Eaux et du Génie Rural, Imprimerie Nationale.
- Nye, J. F. 1958. A theory of wave formation in glaciers (Cambridge Austerdalsbre Expedition). *Union Géodésique et Géophysique Internationale. Association Internationale d'Hydrologie Scientifique. Symposium de Chamonix, 16–24 sept. 1958*, p. 139–54. (Publication No. 47 de l'Association Internationale d'Hydrologie Scientifique.)
- Nye, J. F. 1960. The response of glaciers and ice-sheets to seasonal and climatic changes. *Proceedings of the Royal Society of London, Ser. A*, Vol. 256, No. 1287, p. 559–84.
- Nye, J. F. 1963[a]. On the theory of the advance and retreat of glaciers. *Geophysical Journal of the Royal Astronomical Society*, Vol. 7, No. 4, p. 431–56.
- Nye, J. F. 1963[b]. The response of a glacier to changes in the rate of nourishment and wastage. *Proceedings of the Royal Society of London, Ser. A*, Vol. 275, No. 1360, p. 87–112.
- Nye, J. F. 1965[a]. The flow of a glacier in a channel of rectangular, elliptic or parabolic cross-section. *Journal of Glaciology*, Vol. 5, No. 41, p. 661–90.
- Nye, J. F. 1965[b]. A numerical method of inferring the budget history of a glacier from its advance and retreat. *Journal of Glaciology*, Vol. 5, No. 41, p. 589–607.
- Raymond, C. F. 1971. Flow in a transverse section of Athabasca Glacier, Alberta, Canada. *Journal of Glaciology*, Vol. 10, No. 58, p. 55–84.
- Reynaud, L. 1973. Flow of a valley glacier with a solid friction law. *Journal of Glaciology*, Vol. 12, No. 65, p. 251–58.
- Reynaud, L. [1978.] Glacier fluctuations in the Mont Blanc area (French Alps). *Zeitschrift für Gletscherkunde und Glazialgeologie*, Bd. 13, Ht. 1–2, 1977, p. 155–66.
- Reynaud, L. Unpublished. Étude de la dynamique des séracs du Géant (Massif du Mont-Blanc). [Publication No. 158, Laboratoire de Glaciologie du CNRS, 1973.]
- Reynaud, L., and Courdouan, P. 1962. Reconnaissance du thalweg sous-glaciaire de la Mer de Glace en vue de l'établissement d'une prise d'eau. *Mémoires et Travaux de la Société Hydrotechnique de France*, 1962, No. 2, p. 106–14.
- Röthlisberger, H. 1972. Water pressure in intra- and subglacial channels. *Journal of Glaciology*, Vol. 11, No. 62, p. 177–203.
- Süsstrunk, A. 1951. Sondage du glacier par la méthode sismique. *La Houille Blanche*, 6<sup>e</sup> An., Numéro Spécial A, p. 309–19.
- Vallon, M. 1961. Épaisseur du Glacier du Tacul (Massif du Mont-Blanc). *Comptes Rendus Hebdomadaires des Séances de l'Académie des Sciences (Paris)*, Tom. 252, No. 12, p. 1815–17.
- Vallon, M. Unpublished. Étude de la Mer de Glace. [Thesis, Doctorat d'État, Université de Grenoble, 1967.]
- Vallot, J. 1900. Expériences sur la marche et la variation de la Mer de Glace. *Annales de l'Observatoire Météorologique, Physique et Glaciaire du Mont-Blanc*, Tom. 4, p. 35–157; Tom. 5 [61 plates].
- Weertman, J. 1958. Traveling waves on glaciers. *Union Géodésique et Géophysique Internationale. Association Internationale d'Hydrologie Scientifique. Symposium de Chamonix, 16–24 sept. 1958*, p. 162–68. (Publication No. 47 de l'Association Internationale d'Hydrologie Scientifique.)