

COLOUR SWITCHING AND HOMEOMORPHISM OF MANIFOLDS

MASSIMO FERRI

1. Introduction and notation. Throughout this paper, we work in the PL and pseudosimplicial categories, for which we refer to [17] and [10] respectively. For the graph theory involved see [9].

An h -coloured graph (Γ, γ) is a multigraph $\Gamma = (V(\Gamma), E(\Gamma))$ regular of degree h , endowed with an edge-coloration γ by h colours. If \mathcal{C} is the colour set, for each $\mathcal{B} \subset \mathcal{C}$ we set

$$\Gamma_{\mathcal{B}} = (V(\Gamma), \gamma^{-1}(\mathcal{B})).$$

For each $c \in \mathcal{C}$, set $\hat{c} = \mathcal{C} - \{c\}$. For $n \in \mathbf{Z}$, $n \geq 1$, set

$$\Delta_n = \{i \in \mathbf{Z} | 0 \leq i \leq n\} \quad \text{and} \quad \mathbf{N}_n = \Delta_n - \{0\};$$

Δ_n will be mostly used to denote the colour set for an $(n + 1)$ -coloured graph.

To every $(n + 1)$ -coloured graph (Γ, γ) an n -dimensional pseudocomplex $K(\Gamma, \gamma)$ is associated (often indicated simply as $K(\Gamma)$) whose i -simplexes are in one to one correspondence with the connected components of the subgroups $\Gamma_{\mathcal{B}}$, with $\#\mathcal{B} = n - i$ (for the notion of pseudocomplex, which will be briefly called “complex” in the sequel, see [10, p. 49]). (Γ, γ) is said to *represent* $|K(\Gamma, \gamma)|$. If $\Gamma_{\hat{c}}$ is connected for all $c \in \mathcal{C}$, then there are precisely $n + 1$ vertices (i.e., 0-simplexes) in $K(\Gamma, \gamma)$; in this case (Γ, γ) and with it $K(\Gamma, \gamma)$ are said to be *contracted*. By a theorem of Pezzana (see [15, 16, 1]) there exists, for every closed connected n -manifold M , at least one contracted $(n + 1)$ -coloured graph (Γ, γ) representing M ; (Γ, γ) is then called a *crystallization* of M and $K(\Gamma, \gamma)$ a *contracted triangulation* of M .

The theory of representation of manifolds by $(n + 1)$ -coloured graphs is surveyed in [6]. Of particular interest for the present paper is [3]: its central result is an equivalence theorem for crystallizations, which we will state after having introduced the following notion. Given an $(n + 1)$ -coloured graph (Γ, γ) , a subgraph Θ formed by two vertices, X and Y say, joined by h edges is called a *dipole of type h* or *h -dipole* if, on setting $\mathcal{B} = \gamma(E(\Theta))$, X and Y lie in distinct components of $\Gamma_{\mathcal{C} - \mathcal{B}}$; an h -dipole is said to be *nondegenerate* if $2 \leq h \leq n - 1$. To *cancel* or to *eliminate* a dipole Θ means to form the graph Γ' , where $V(\Gamma') = V(\Gamma) - \{X, Y\}$ and

Received January 14, 1983. This work was performed under the auspices of the G.N.S.A.G.A. of the C.N.R. and within the Project “Geometria delle Varietà differenziabili” of the M.P.I. (Italy).

where $E(\Gamma')$ is obtained from $E(\Gamma) - E(\Theta)$ by “pasting together” the pairs of equally coloured edges coming to X and Y from outside Θ ; *adding* or *introducing* a dipole is the inverse operation. A *cut* (resp. *glueing*) is the adding (resp. cancelling) of a dipole of type I. Given a dipole Θ in (Γ, γ) , the colours of $\gamma(E(\Theta))$ will be said to be *involved* in Θ and in the moves (defined below) concerning addition or cancellation of Θ . A *cut-and-glue* or *move of type I* is a cut followed by a glueing involving the same colour. A *move of type II* is the adding or cancelling of a nondegenerate dipole. If (Γ, γ) is contracted, the graph obtained by a move of type I or II is again contracted. The main theorem of [3] states that two crystallizations represent homeomorphic manifolds if and only if they are obtained from each other by a finite sequence of moves of type I and/or II.

We now state the central proposition of the present paper:

SWITCHING LEMMA. *Let (Γ, γ) be a crystallization of a closed connected n -manifold M . Further let $r, s \in \Delta_n$, $r \neq s$, and let $\eta: \Delta_n \rightarrow \Delta_n$ be the permutation which interchanges r with s . Then $(\Gamma, \eta\gamma)$ can be obtained from (Γ, γ) by a finite sequence of moves involving colour r and not involving colour s .*

The Switching Lemma will be proved in Section 5: In Section 2 we recall, with new proofs, some lemmas of [3] and Section 3 is dedicated to a graph-theoretical proposition whose application, given in Section 4, will be essential for the proof. The next theorem, which is a direct consequence of the Switching Lemma, will be proved in Section 6.

THEOREM 1. *Let $l \in \Delta_n$ be arbitrarily fixed, and let two crystallizations (Γ, γ) and (Γ', γ') , of manifolds M and M' respectively, be given. The following statements are then equivalent:*

- (1) M is homeomorphic to M' ;
- (2) (Γ', γ') can be obtained from (Γ, γ) by a sequence of moves involving the colour l ;
- (3) (Γ', γ') can be obtained from (Γ, γ) by a sequence of moves not involving the colour l .

Theorem 1 strongly sharpens the equivalence theorem of [3] by allowing the moves to be taken from restricted sets. This result assumes a particular relevance in view of the increasing interest in this theory, recently shown also by other schools (see [12, 13, 14, 18]). Theorem 1 promises to be of use in further research of which we now give samples. Firstly, a strong form of equivalence is needed to prove the additivity of the “regular genus” of manifolds (for this invariant see [7, 8, 4, 5]). Secondly, it can also possibly shed some light in the (so long unsuccessful) search for link moves of 2-fold branched coverings of S^3 ([11, Problem 3.25]), via the construction of [2]. Finally, let us mention an ambitious project which becomes more realistic, now that the type of invariance required can be

considerably weakened, that is, we hope to find or construct graph-theoretical invariants (e.g. of the type of the many existing recursive polynomials) which agree on crystallizations of homeomorphic manifolds, and give rise to new significant manifold invariants; some functions of this type have already been found, but they reduce to classical topological invariants.

From now on, all n -manifolds will be closed and connected, unless otherwise stated, and with $n \geq 2$. *Facet* will mean an $(n - 1)$ -simplex in an n -dimensional complex. In an n -complex $K = K(\Gamma, \gamma)$, the subcomplex \mathcal{D} corresponding to an h -dipole Θ will also be called an h -dipole; it is formed by two n -simplexes having in common h facets (and all faces of these facets), which we shall call *meet-facets*. The vertices opposite to the meet-facets in both n -simplexes will be said to be *involved* in \mathcal{D} as well as (in the case of $h = 1$ and before a cut or after a glueing) the vertex obtained by identifying the two vertices involved in \mathcal{D} . In the sequel, the terms *dipole*, *meet-facet*, *involved vertex* will apply to such a subcomplex \mathcal{D} even if K is not associated to any graph. In a dipole \mathcal{D} , all faces not contained in a meet-facet occur in pairs: such a pair of i -simplexes s^i, s'^i (generated by the same vertices) reduces to one simplex s^i when \mathcal{D} is cancelled; we shall say that the adding of \mathcal{D} *doubles* s^i into s^i and s'^i . Two complexes are said to be *equal up to dipoles* if they are obtained from each other by a finite sequence of addings and/or cancellings of dipoles.

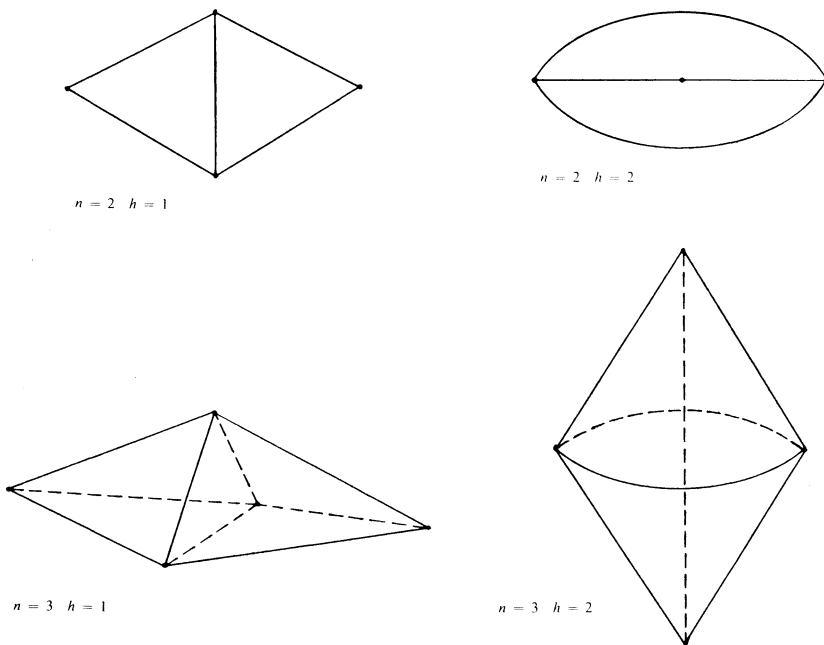

Figure 1

Figure 1 illustrates “geometric” dipoles for $n = 2, 3$ and $h = 1, 2$. An h -dipole in dimension n can be thought of as a join from an $(n - m - 1)$ -simplex over an h -dipole in a lower dimension m .

2. Cone-algorithms. Given a simplex s in an n -complex K , the *disjoined star* of s in K , $\text{std}(s, K)$, is defined to be the disjoint union of the n -simplexes of K containing s , with re-identification of the facets containing s , and of their faces. The *disjoined link* of s in K , $\text{lkd}(s, K)$, is the subcomplex of $\text{std}(s, K)$ (actually of its boundary $\partial\text{std}(s, K)$) consisting of simplexes disjoint from s . If $K = K(\Gamma, \gamma)$ for an $(n + 1)$ -coloured graph (Γ, γ) , an i -simplex s^i corresponds to a component of a $\Gamma_{\mathcal{B}}$ with $\#\mathcal{B} = n - i$, as we have said; this component, as an $(n - i)$ -coloured graph, represents the complex $\text{lkd}(s^i, K)$.

The following concepts have been introduced, in a slightly different way, in [3]. Given a complex K , a vertex $v \in K$ is called a *cone-vertex* if $v \in s$ for all n -simplexes s of K . Let M be a fixed n -manifold \mathbb{C}^i (with $i \in \Delta_n$) denotes the class of pairs $(K, \{w_0, \dots, w_{i-1}\})$, where K is a complex representing M , and has at least i cone-vertices w_0, \dots, w_{i-1} . A *cone-algorithm* \mathcal{A} on $(K, \{w_0, \dots, w_{i-1}\}) \in \mathbb{C}^i$ is the construction of a pair

$$\mathcal{A}(K, \{w_0, \dots, w_{i-1}\}) = (\mathcal{A}(K), \{w_0, \dots, w_{i-1}, w_i\}) \in \mathbb{C}^{i+1}$$

carried out as follows: Consider the disjoined stars of the $(n - i)$ -simplexes of K not containing any of w_0, \dots, w_{i-1} , as disjoint n -balls; attach them together through facets, to form an n -ball D in which any two disjoined stars have at most one facet in common; pseudodissect $|D|$ as the join from an inner point w_i over $\Sigma = \partial D$; re-identify the *twin* facets of Σ , i.e., the two facets of each pair coming from one facet of K . The out-coming complex $\mathcal{A}(K)$ still has M as its space, and has w_i as a further cone-vertex.

Obviously, there are different cone-algorithms \mathcal{A} on K , corresponding to the different ways of forming D ; $\mathfrak{A}(K)$ is the set of all possible complexes $\mathcal{A}(K)$.

We will not be very strict about the notation $(K, \{w_0, \dots, w_{i-1}\})$: If no confusion arises about the set $\{w_0, \dots, w_{i-1}\}$, we will speak of K itself as an element of \mathbb{C}^i .

We now recall some lemmas from [3] and give some alternative proofs which will be used in the sequel.

LEMMA 2. *Let $K \in \mathbb{C}^i, i \in \Delta_n$. If $K', K'' \in \mathfrak{A}(K)$, then K'' (resp. K') is obtained from K' (resp. from K'') by a finite sequence of cut-and-glue moves.*

Remark 1. Note that, in the preceding lemma, all cut-and-glues involve the last cone-vertex introduced.

Consider $L \in \mathbb{C}^i$, $i \in \Delta_n$, and let $K \in \mathfrak{A}(L)$ be the complex obtained from the ball $w_i * \Sigma$ by identification of twin facets of Σ . Let

$$p: w_i * \Sigma \rightarrow K$$

be the canonical projection. Let \mathcal{D} be a dipole of type h ($1 \leq h \leq n - 1$) in Σ , and Σ' be the complex obtained from Σ by cancelling \mathcal{D} .

LEMMA 3. *If the two $(n - 1)$ -simplexes forming \mathcal{D} are twin, then $p(w_i * \mathcal{D})$ is a dipole of type $h + 1$ in K . Moreover, the pseudocomplex K' obtained from K by cancelling $p(w_i * \mathcal{D})$ is $p(w_i * \Sigma')$.*

The next lemma is not contained in [3]. Let $\mathcal{D}, \Sigma, \Sigma', p$ be as before, and let a, b be the two $(n - 1)$ -simplexes forming \mathcal{D} , $a' \neq a, b' \neq b$ be the $(n - 1)$ -simplexes twin to a, b respectively, and e, f the $(h - 1)$ -faces of a, b respectively, opposite to all meet-facets of \mathcal{D} .

LEMMA 3'. *If $p(e) \neq p(f)$, then $p(w_i * \mathcal{D})$ is a dipole of type h in K . Moreover, the pseudocomplex K' obtained from K by cancelling $p(w_i * \mathcal{D})$ is $p'(w_i * \Sigma')$, where p' agrees with p on all of Σ' except on those a', b' for which $p'(a') = p'(b')$.*

Proof. This is straightforward.

Remark 2. In both Lemmas 3 and 3' the vertices involved in \mathcal{D} are also involved in $p(w_i * \mathcal{D})$; in the case of Lemma 3, the vertex w_i is also involved.

LEMMA 4a. *If $K \in \mathbb{C}^{i+1}$, $i \in \Delta_n$, then there exist $L \in \mathbb{C}^i$ and $K' \in \mathfrak{A}(L)$ such that K and K' are equal up to dipoles of type $h \geq 2$. In particular, if $i = n$, then K, L, K' coincide.*

LEMMA 4b. *If $K, L \in \mathbb{C}^0$, then there exist $K' \in \mathfrak{A}(K), L' \in \mathfrak{A}(L)$ which are equal up to dipoles of type $h \geq 2$.*

LEMMA 4c. *If $K, L \in \mathbb{C}^i$, $i \in \Delta_n$, are equal up to dipoles of type $h \geq 2$, then there exist $K' \in \mathfrak{A}(K)$ and $L' \in \mathfrak{A}(L)$, which are equal up to dipoles of type $h' \geq 2$ if $i < n$, up to dipoles of type $h', 2 \leq h' \leq n - 1$ (i.e., nondegenerate), if $i = n$.*

Proof. Let us assume that $K, L \in \mathbb{C}^i$, $i \in \Delta_n$, and that K is obtained from L by cancelling a dipole \mathcal{D} of type $h \geq 2$ formed by two n -simplexes x and y . Let α be the set of $n - h + 1$ vertices common to all meet-facets of \mathcal{D} , β be the set of the h remaining vertices of \mathcal{D} , γ be the set of cone-vertices of L . We exclude the trivial case of $K = \emptyset, L = \mathcal{D}$.

1) Case $\gamma \subseteq \alpha$. Let r , with $0 \leq r \leq n - h + 1$, be the cardinality of $\alpha - \gamma$; the set of non-cone-vertices of \mathcal{D} is $\beta \cup (\alpha - \gamma)$, and generates two $(h + r - 1)$ -simplexes s_1 and s_2 . All h meet-facets of \mathcal{D} and the r non-meet-facets of x not containing s_1 are on $\partial \text{std}(s_1, L)$; analogously for

s_2 . Build a cone-algorithm \mathcal{A} in which (*) $\text{std}(s_1, L)$ and $\text{std}(s_2, L)$ are attached together by one meet-facet of \mathcal{D} , and (**) if $i > 0$, no other facet is internal to the ball D of the cone-algorithm, whereas if $i = 0$ then just one facet of \mathcal{D} is internal. (When $i = 0$, i.e., $r = n - h + 1$, at least one facet f has to be made internal to the ball D of the cone-algorithm \mathcal{A} . Note that, if $f \subset x$, the facet of y with the same vertices substitutes, in Σ'' , the facet twin to f .) The corresponding sphere $\Sigma = \partial D$ contains $h - 1$ dipoles of type 1 whose simplexes are twin (from the meet-facets).

The subcomplex of \mathcal{D} formed by these dipoles fits in the following description of a complex $S_{l,m}$, with $l = h, m = 1$, and \bar{s} generated by α .

For all $l \in \mathbf{N}_n$, all $m \in \mathbf{N}_{l-1}$ let $P_{l,m}$ be an $(l - 1)$ -dimensional m -dipole: Define the complex $S_{l,m}$ as the join of $\partial P_{l,m}$ with an $(n - l)$ -simplex \bar{s} .

Note that the j -th dipole cancellation ($j \in \mathbf{N}_{h-2}$) transforms an $S_{h,j}$ into an $S_{h,j+1}$, (here and after we intend $\mathbf{N}_0 = \emptyset$) so that it raises the type of the remaining dipoles by one. So, elimination of $h - 1$ dipoles, one for each type $j \in \mathbf{N}_{h-1}$, yields a Σ'' , in which the remaining facets from \mathcal{D} form r' dipoles of type h , where

$$r' = \min\{r, n - h\};$$

note that the facets of each of these dipoles are not twin. The subcomplex of Σ'' formed by these dipoles is an $S_{r'+h,h}$, where, if $r' = r, \bar{s}$ is generated by β and the two intersections of non-meet-facets of $P_{r'+h,h}$ are generated by δ .

Again, the k -th dipole cancellation ($k \in \mathbf{N}_{r'-1}$) transforms an $S_{r'+h,h+k-1}$ into an $S_{r'+h,h+k}$, and hence raises the type of the remaining dipoles. Thus, cancellation of r' dipoles of type $h + k - 1$, one for each $k \in \mathbf{N}_{r'}$, yields a Σ' which can be considered as the boundary of a ball D' relative to a cone-algorithm \mathcal{A}' for K .

Note that, for each $k \in \mathbf{N}_{r'-1}$, the two $(h + k - 2)$ -dimensional intersections of non-meet-facets of $P_{r'+h,h+k-1}$ come from two distinct simplexes of L , which the first sequence of dipole eliminations has not identified; the k -th dipole elimination of the second sequence does identify them, but not the $(h + k - 1)$ -dimensional intersections of non-meet-facets of $P_{r'+h,h+k}$. This grants that for each of these r' dipoles Lemma 3' applies.

By repeated application of Lemmas 3 and 3', $K' = \mathcal{A}'(K)$ is obtained from $L' = \mathcal{A}(L)$ by cancelling $h - 1$ dipoles of increasing types $j + 1$, one for each $j \in \mathbf{N}_{h-1}$, and r' dipoles of increasing types $h + k - 1$, one for each $k \in \mathbf{N}_{r'}$. Note that, if $h < n$, all these dipoles are of type $< n$, since we always have, by definition, $h + r' - 1 < n$.

2) Case $\beta \not\subset \alpha$. Let q, r (with $0 \leq q \leq h - 1, 0 \leq r \leq n - h + 1$, and $q + r \geq 1$) be the cardinalities of $\delta - \beta$ and $\alpha - \beta$ respectively. The union of these two sets generates, in \mathcal{D} , a unique $(q + r - 1)$ -simplex s , which is

contained in $h - q$ meet-facets and in $2(n - h - r + 1)$ non-meet facets. Such facets become internal to $\text{std}(s, L)$, while the remaining ones are on $\partial\text{std}(s, L)$. Build a cone-algorithm \mathcal{A} for L such that (\$) if $r < n - h + 1$, no facets of $\partial\text{std}(s, L)$ become internal to the corresponding ball D and, if $r = n - h + 1$, just one does. Then, on $\Sigma = \partial D$ there are q dipoles of type $h - q$, whose simplexes are twin. Elimination of these dipoles, which successively become of increasing types $h - j$, one for each $j \in \mathbb{N}_q$, yields a Σ'' on which there are r' (with $r' = \min\{r, n - h\}$) dipoles of type h , consisting of non-twin simplexes. Cancellation of r' dipoles of increasing types $h + k - 1$, one for each $k \in \mathbb{N}_{r'}$, finally yields a sphere Σ' corresponding to the ball D' of a cone-algorithm \mathcal{A}' for K . By Lemmas 3 and 3', $\mathcal{A}'(K)$ is obtained from $\mathcal{A}(L)$ by cancelling q dipoles of increasing types $h - j + 1$, one for each $j \in \mathbb{N}_q$, and r' dipoles of increasing types $h + k - 1$, one for each $k \in \mathbb{N}_{r'}$. Note that the highest possible type, for a dipole to be cancelled, is the maximum between h and $h + (n - h) - 1 = n - 1$. Also observe that, for $h = n, r = n - h + 1 = 1, q = 0$ (which corresponds to the case of $h = n, i = n$), no dipole has to be cancelled.

Remark 3. We shall later encounter Case 2 of the preceding proof, with $r = 1, q = 0$. Note that $\mathcal{A}'(K)$ and $\mathcal{A}(L)$ differ, in this situation, by just one dipole of type h , which involves the same vertices as \mathcal{D} . Therefore, in this case we can express Lemma 4c in the following special form: Let K be obtained from L by cancelling a dipole of type h , and let \mathcal{A} be any cone-algorithm on L satisfying condition (\$). Then there is a complex $K' \in \mathfrak{A}(K)$ which is obtained from $\mathcal{A}(L)$ by cancelling a dipole of type h , involving the same vertices.

LEMMA 4d. *Let $L, L' \in \mathfrak{C}^i, i \in \mathbb{N}_n$, be obtained from each other by a cut-and-glue involving the i -th cone-vertex, and let $H \in \mathfrak{A}(L), H' \in \mathfrak{A}(L')$. Then H and H' are obtained from each other by a finite sequence of cut-and-glues and of addings and cancellings of nondegenerate dipoles.*

Proof. Let \bar{L} be the pseudocomplex obtained from L (and, respectively, from L') by adding the dipole of type 1 \mathcal{D} (resp. \mathcal{D}') with meet-facet f (resp. f'). Let α, α' be the sets of vertices of f and f' respectively. Let $\bar{\alpha}$ be the set of cone-vertices of \bar{L} .

By hypothesis, a cone-vertex of L (and, respectively, one of L' with the same name) has been doubled into two non-cone-vertices w, w' by the introduction of \mathcal{D} (resp. of \mathcal{D}'). Set $r = n - i$: r is the cardinality both of $\alpha - \bar{\alpha}$ and $\alpha' - \bar{\alpha}$. The non-cone-vertices, different from w and w' , generate $(r - 1)$ -simplexes in \bar{L} ; two of them, s and s' say, are in \mathcal{D} and \mathcal{D}' respectively. Consider the disjointed stars of all such $(r - 1)$ -simplexes; build, as in a cone-algorithm $\bar{\mathcal{A}}$, an n -ball \bar{D} by attaching such stars along facets, but so that (*) if $r < n$ (i.e., $i > 0$), no facets of \mathcal{D} (and, respectively, of \mathcal{D}') belonging to $\partial\text{std}(s, \bar{L})$ (resp. to $\partial\text{std}(s', \bar{L})$) become internal to \bar{D} , and if $r = n$ just one of either star boundary does. Take a point v inner to

\bar{D} , consider the join from v over $\bar{\Sigma} = \partial\bar{D}$, and identify the twin facets of $\bar{\Sigma}$; call $\bar{K} = \bar{\mathcal{A}}(\bar{L})$ the out-coming complex. The situation is now similar to the one of Case 2 of the proof of the preceding lemma, with $q = 1$. Then, there is a cone-algorithm \mathcal{A} on L (and, respectively, one \mathcal{A}' on L') such that $\mathcal{A}(L)$ (resp. $\mathcal{A}'(L')$) can be obtained from $\bar{\mathcal{A}}(\bar{L})$ by cancelling $r' = \min\{r, n - 1\}$ dipoles of increasing types j , one for each $j \in \mathbb{N}_{r'}$ (where the first dipole involves w and w' , by Remark 2). This means that $\mathcal{A}'(L')$ and $\mathcal{A}(L)$ are obtained from each other by $r' - 1$ additions of nondegenerate dipoles, one cut-and-glue, and $r' - 1$ cancellings of nondegenerate dipoles.

In both Cases 1 and 2, application of Lemma 2 to H and $\mathcal{A}(L)$, and to H' and $\mathcal{A}'(L')$, concludes the proof.

Remark 4. Note that the dipoles of type 1 of the preceding proof involve w and w' , as \mathcal{D} and \mathcal{D}' did. We shall later meet this case, with $r = 1$; in this situation, $\mathcal{A}'(L')$ and $\mathcal{A}(L)$ are obtained from each other by just a single cut-and-glue, which involves the same vertex as the one joining L and L' .

Remark 5. Again in the proof of Lemma 4d, one does not obtain, from $\bar{\mathcal{A}}(\bar{L})$, all possible cone-algorithms \mathcal{A} and \mathcal{A}' for L and L' . This depends on the condition (*) we have imposed. More precisely, if \mathcal{A} is given with condition (*) satisfied for \mathcal{D}' in $\mathcal{A}(L)$, then a single cut-and-glue takes $\mathcal{A}(L)$ to an $\mathcal{A}'(L')$ such that \mathcal{A}' satisfies the same condition for \mathcal{D} .

3. Clefts in graphs. The following definitions have been suggested by concepts introduced in [18]. In this and in the next section the term “graph” will stand for “pseudograph” (also loops are allowed).

Let Ξ be a finite graph and, for $j \in \mathbb{N}_h$, \mathcal{F}_j a family of disjoint cycles of Ξ . We shall name a cycle along with its edge set, so that $\cup \mathcal{F}_j$ will denote the set of edges belonging to at least one cycle of \mathcal{F}_j . An edge $e \in E = E(\Xi)$ is said to be \mathcal{F}_j -*belonging* if there is a cycle $c \in \mathcal{F}_j$ such that $e \in c$. Let A be a subset of E ; an edge $e \notin A$ is said to be \mathcal{F}_j -*dependent on A* if there is a cycle $c \in \mathcal{F}_j$ such that $e \in c \subseteq A \cup \{e\}$ (so that e is also \mathcal{F}_j -belonging). A *cleft* of Ξ with respect to the given cycle sets is a sequence of edges (e_0, \dots, e_k) such that, for each $i \in \mathbb{N}_k$ and for some $j \in \mathbb{N}_h$, e_i is \mathcal{F}_j -belonging but not \mathcal{F}_j -dependent on $E - \{e_0, \dots, e_i\}$ (i.e., there exists a cycle $c \in \mathcal{F}_j$ such that c contains e_i and some of the edges e_0, \dots, e_{i-1}).

An example of a cleft is shown in Figure 2b of the next section; indeed, the whole sense of a cleft is better understood through the application of Section 4.

PROPOSITION 5. *Let $\mathcal{F}_1, \dots, \mathcal{F}_h$ be families of cycles in a connected graph $\Xi = (V, E)$, such that*

- (i) $\cup_j (\cup \mathcal{F}_j) = E$, and
- (ii) for all h -tuples of subsets $\mathcal{F}'_j \subseteq \mathcal{F}_j$,

$$(\emptyset \neq \cup_j(\cup \mathcal{F}'_j) \neq E) \Rightarrow ((\cup_j(\cup \mathcal{F}'_j) \cap (\cup_j(\cup C_{\mathcal{F}_j} \mathcal{F}'_j))) \neq \emptyset).$$

Then, for any $e_0 \in E$ there exists a cleft (e_0, \dots, e_k) such that $E - \{e_0, \dots, e_k\}$ generates a spanning tree of Ξ .

Proof. Assume a cleft (e_0, \dots, e_i) has already been built, such that Ξ_i , the subgraph generated by $E_i = E - \{e_0, \dots, e_i\}$, is connected; note that Ξ is necessarily 2-edge-connected, since E is covered by cycles, so that Ξ_0 is connected.

We are going to show that either Ξ_i is a spanning tree, or it can be reduced to a Ξ_{i+1} satisfying the same assumption, by a cleft extension. By virtue of the finiteness of Ξ , we shall eventually get a spanning tree.

Either (1) for every $e' \in E_i$, and for all $j \in \mathbf{N}_h$, e' is not \mathcal{F}_j -dependent on $E_i - \{e'\}$, or (2) there is at least one $e \in E_i$ which is \mathcal{F}_l -dependent on $E_i - \{e\}$ for some $l \in \mathbf{N}_h$.

In case (1), as Ξ_i is connected, either it is a spanning tree, or there is an $e_{i+1} \in E_i$ such that $E_i - \{e_{i+1}\}$ generates a connected subgraph. By the hypothesis (i), e_{i+1} is \mathcal{F}_j -belonging for some j , so $(e_0, \dots, e_i, e_{i+1})$ is a cleft.

In case (2), there are a priori two subcases: (2') for all $e \in E_i$, and for all $l, m \in \mathbf{N}_h$, $l \neq m$, if e is \mathcal{F}_l -dependent on $E_i - \{e\}$ and \mathcal{F}_m -belonging, then e is also \mathcal{F}_m -dependent on $E_i - \{e\}$; (2'') at least one e_{i+1} is \mathcal{F}_l -dependent on $E_i - \{e_{i+1}\}$, for some $l \in \mathbf{N}_h$, but is \mathcal{F}_m -belonging for some other $m \in \mathbf{N}_h$ without being \mathcal{F}_m -dependent on $E_i - \{e_{i+1}\}$.

In the latter subcase (2''), $(e_0, \dots, e_i, e_{i+1})$ is a cleft and Ξ_{i+1} is connected. We now assume the subcase (2'), and show that it cannot subsist, so concluding the proof. Let A be the set of those $e \in E_i$ for which there exists an $l \in \mathbf{N}_h$ such that e is \mathcal{F}_l -dependent on $E_i - \{e\}$. Also consider the families

$$\mathcal{F}'_j = \{c \in \mathcal{F}_j \mid c \cap A \neq \emptyset\} \quad (j \in \mathbf{N}_h).$$

Note that $A \neq \emptyset$ since we are in (2'), and that $A \subseteq E_i \neq E$. Let $e \in c \in \mathcal{F}'_m$ for some $m \in \mathbf{N}_h$; then there exists an $e' \in c \cap A$: e' is then \mathcal{F}_l -dependent on $E_i - \{e'\}$ for some l (since $e' \in A$). If $l = m$, then also $e \in A$. Assuming that $l \neq m$, e' is \mathcal{F}_m -belonging (since $e' \in c \in \mathcal{F}_m$), hence e' is \mathcal{F}_m -dependent on $E_i - \{e'\}$, i.e., $c \subseteq E_i$. Therefore, also e is \mathcal{F}_m -dependent on $E_i - \{e\}$, and $e \in A$: this shows that

$$\cup_j(\cup \mathcal{F}'_j) \subseteq A.$$

Since the inverse inclusion is obvious, we have

$$\cup_j(\cup \mathcal{F}'_j) = A.$$

By construction, each $\cup C_{\mathcal{F}_j} \mathcal{F}'_j$ is disjoint from A , thus

$$(\cup_j(\cup \mathcal{F}'_j) \cap (\cup_j(\cup C_{\mathcal{F}_j} \mathcal{F}'_j))) = \emptyset,$$

but this contradicts the hypothesis (ii).

4. v_l -centered cone-algorithms. Let (Γ, γ) be a crystallization of an n -manifold M ; on setting $K = K(\Gamma, \gamma)$ and calling v_0, \dots, v_n its vertices, we have

$$(K, \{v_i | i \in \Delta_n\}) \in \mathfrak{C}^{n+1}.$$

Later we shall need to neglect two vertices of K , v_l and v_m say, as cone-vertices, so consider

$$(K, \{v_i | i \in \Delta_n - \{l, m\}\}) \in \mathfrak{C}^{n-1}.$$

In order to define a cone-algorithm \mathcal{A} on

$$(K, \{v_i | i \in \Delta_n - \{l, m\}\}),$$

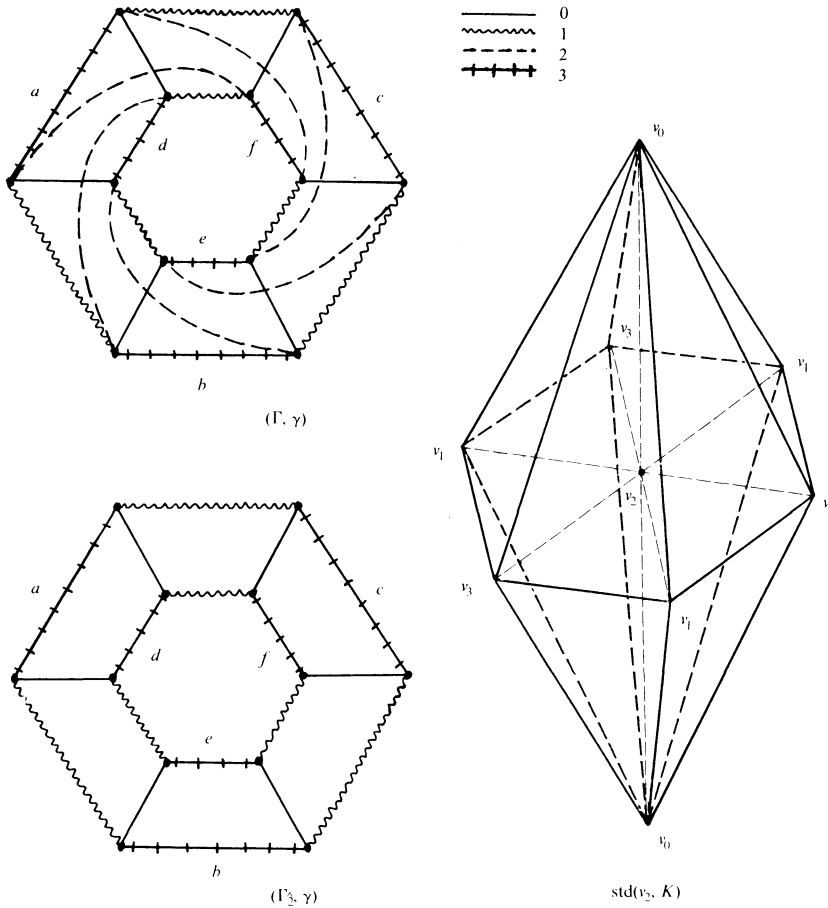

Figure 2a. $\mathcal{F}_1 = \{a, b, c\}$, $\mathcal{F}_2 = \{d, e, f\}$, $\mathcal{F}_3 = \{a, d\}$, $\mathcal{F}_4 = \{c, f\}$, $\mathcal{F}_5 = \{b, e\}$; cleft: (e, d, f, b) .

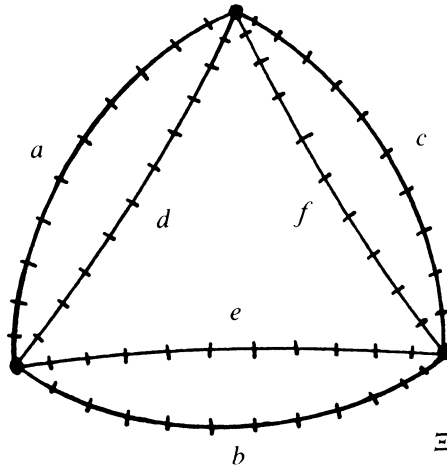

Figure 2b

and then pass to \mathbb{C}^n , one has to specify a set ζ of facets along which to attach the disjointed stars of the 1-simplexes of vertices v_l and v_m . A cone-algorithm \mathcal{A} in which ζ is chosen to consist only of facets containing v_l will be said to be v_l -centered. If \mathcal{A} is v_l -centered, then on the boundary of the associated ball D there will be only one copy of v_l . Indeed, D can be thought of as $\text{std}(v_l, K)$ “fissured” along the facets not in ζ . We shall call *incision along a facet f* the operation inverse to that the identification of two twin facets into f . Observe that the identification of two facets brings the identification of their faces with it; so an incision has an effect also on lower-dimensional simplexes.

We are going to show that a set of incisions exists, which (with the obvious exception of the first) merely extends the “wound” opened by the preceding ones.

Figure 2 illustrates the next proof by (a) a crystallization of $L(3, 1)$, with the corresponding Γ_2^3 and $\text{std}(v_2, K)$, (b) a cleft on the related Ξ , and (c) the incisions produced by the cleft. The choice of $l = 2$, $m = 3$, rather than following the convention of the proof, has been made in view of a later application.

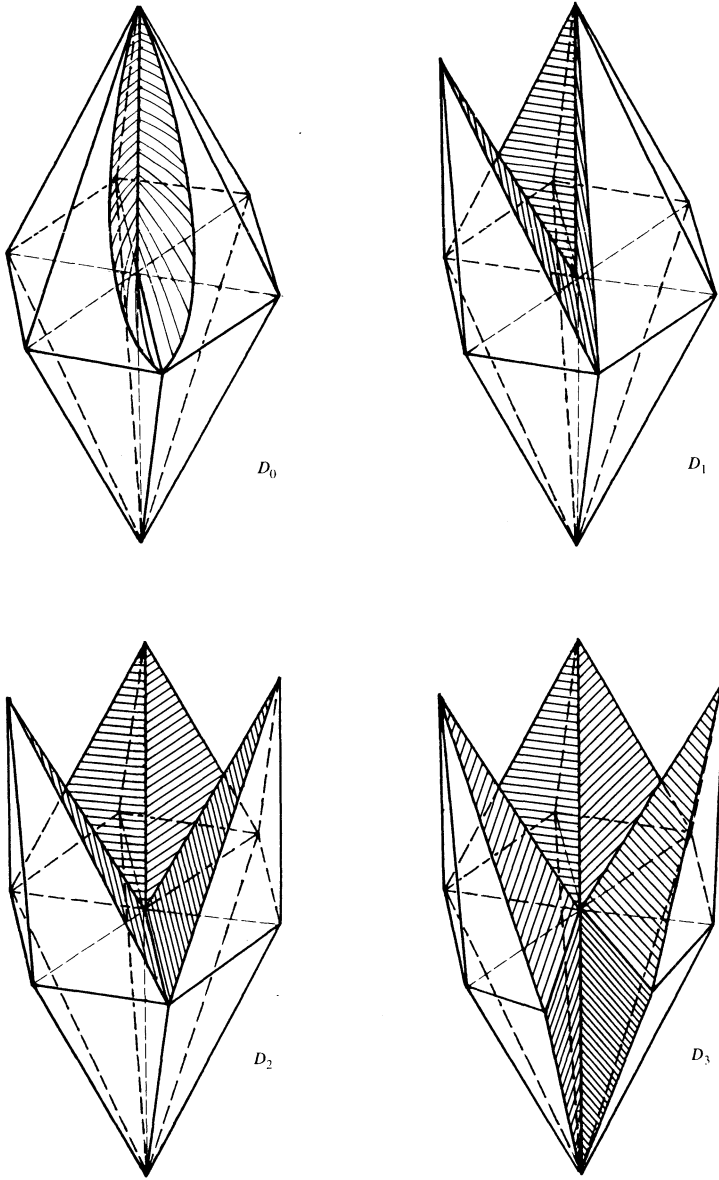

Figure 2c

PROPOSITION 6. *Let (Γ, γ) be a crystallization of an n -manifold M , and $\{v_i | i \in \Delta_n\}$ be the vertex set of $K = K(\Gamma, \gamma)$. Let $l, m \in \Delta_n$, $l \neq m$, be arbitrarily fixed, and let the complex K be called L after v_l is renamed w .*

Then there exists a v_l -centered cone-algorithm \mathcal{A} on

$$(K, \{v_i | i \in \Delta_n - \{l, m\}\}) \in \mathbb{C}^{n-1},$$

which yields a pair

$$(\mathcal{A}(K), \{v_i | i \in \Delta_n - \{l, m\}\} \cup \{w\}) \in \mathbb{C}^n,$$

such that $\mathcal{A}(K)$ is obtained from L by adding one n -dipole (which doubles an arbitrarily chosen facet not containing v_m) and a set of nondegenerate dipoles, all involving w .

Proof. Without loss of generality, let $l = n, m = n - 1$. Form, as in the proof of Lemma 4a (see [3]), a graph Ξ , whose vertices are the disjointed stars of the 1-simplexes with vertices v_{n-1}, v_n , and whose edges are the facets, on the star boundaries, which contain v_n . In point of fact, Ξ is the graph obtained from $\Gamma_{\hat{n}}$ by contracting all edges not coloured $n - 1$.

Now, if one attaches the disjointed stars along all the facets represented in Ξ , one gets $\text{std}(v_n, K)$, while the ball D of the desired cone-algorithm corresponds to a spanning tree of Ξ . The incision of $\text{std}(v_n, K)$ along such a facet, which yields a ball D_0 , corresponds to the elimination of an edge e_0 of Ξ . The same incision also corresponds to introducing a dipole \mathcal{D} of type $n - 1$, formed by two twin simplexes, into the sphere

$$\Sigma = \partial \text{std}(v_n, K) = \text{lkd}(v_n, K),$$

so getting a sphere $\Sigma_0 = \partial D_0$; the complex $K_0 = p(w * \Sigma_0)$ is obtained from $K = p(v_n * \Sigma)$ by adding $p(w * \mathcal{D})$ which, by Lemma 3 and Remark 2, is a dipole of type n involving w .

If $n = 2$, K_0 is already the desired $\mathcal{A}(K)$; therefore assume, from now on, that $n \geq 3$.

Assume that we have incised D_0 i times into a ball D_i , so that $\Sigma_i = \partial D_i$ is obtained from Σ_0 by addings of nondegenerate dipoles; then, also

$$K_i = p(w * \Sigma_i)$$

has been obtained from K_0 by addings of nondegenerate dipoles involving w ; correspondingly, a set of edges e_1, \dots, e_i is cancelled from Ξ_0 , so yielding a connected graph Ξ_i .

Now, we ask when a further incision along a facet f gives rise to a nondegenerate dipole, made of twin simplexes, in Σ_i , and hence also to a nondegenerate dipole involving w in K_i . It is not hard to see that such a possible f is one which has at least two of its $(n - 2)$ -faces on Σ_i ; to ensure that this happens, choose f in the star of an $(n - 2)$ -face s^{n-2} "brought to the surface" by the preceding incisions, i.e., such that (with slightly improper notation), $v_n \in s^{n-2} \in \Sigma_i$. Next, we characterize the edges of Ξ_i corresponding to such facets.

For each colour $j \in \Delta_{n-2}$, consider the family $\bar{\mathcal{F}}_j$ of cycles into which

$\Gamma_{\{n-1,j\}}$ splits; these families $\bar{\mathcal{F}}_j$ ($j \in \Delta_{n-2}$) subsist also in $\Gamma_{\hat{n}}$. After contraction, these sets give rise to as many families \mathcal{F}_j of (possibly nonelementary) cycles in Ξ .

An $s^{n-2} \in K$ containing v_n corresponds, in Γ , to a bicoloured cycle \bar{c} of $\Gamma_{\hat{n}}$; since incisions can be carried out only along facets opposite to v_{n-1} , we are interested only in edges coloured $n - 1$; then, colour $n - 1$ has to be one of the two colours of \bar{c} . This means that $\bar{c} \in \bar{\mathcal{F}}_j$ for some j ; therefore, the same s^{n-2} corresponds, in Ξ , to a cycle $c \in \mathcal{F}_j$. Now, $s^{n-2} \in \Sigma_i$ if and only if at least one edge $e \in \{e_0, \dots, e_i\}$ belongs to c ; if this is the case, f can be chosen to correspond to an edge $e_{i+1} \in c - \{e_0, \dots, e_i\}$; by definition, e_{i+1} is \mathcal{F}_j -belonging, but not \mathcal{F}_j -dependent on $E(\Xi) - \{e_0, \dots, e_i, e_{i+1}\}$.

Lastly, a cone-algorithm \mathcal{A} of the desired type exists, if there is a cleft (e_0, \dots, e_k) of Ξ , with respect to $\{\mathcal{F}_j\}$, which yields a spanning tree Ξ_k . In view of Proposition 5, this is the case if the families \mathcal{F}_j ($j \in \Delta_{n-2}$) satisfy conditions (i) and (ii) of that statement.

Condition (i) is satisfied by construction. We now give an indirect proof of condition (ii).

Assume that there are subfamilies $\mathcal{F}'_j \subseteq \mathcal{F}_j$ ($j \in \Delta_{n-2}$) such that

$$\cup_j (\cup \mathcal{F}'_j) = A,$$

a proper nonvoid subset of $E = E(\Xi)$, and that

$$\cup_j (\cup C_{\mathcal{F}'_j}) = C_E A,$$

so denying the condition. Now, the vertices of Ξ can be put, in a natural way, in bijection with the disjointed stars (which are $(n - 1)$ -balls) of the copies of v_{n-1} in Σ ; analogously, the edges of Ξ correspond to $(n - 2)$ -balls (actually simplexes) of Σ , which do not contain copies of v_{n-1} . Then $|\Sigma|$ can also be seen as the space of an $(n - 1)$ -dimensional ball-complex, whose dual 1-skeleton is Ξ . Each cycle of $\cup_j \mathcal{F}_j$ corresponds to the set of $(n - 1)$ -balls containing a well-determined $(n - 3)$ -simplex of Σ , which in turn does not contain copies of v_{n-1} .

To a connected, proper, nonempty subgraph Ξ' of Ξ there corresponds an $(n - 1)$ -dimensional, proper, nonempty sub-pseudomanifold P of Σ , possibly with boundary. P has nonempty boundary if and only if some of its $(n - 2)$ -simplexes have a noncyclic star in P , i.e., for some $j \in \Delta_{n-2}$ and for some $c \in \mathcal{F}_j$,

$$\emptyset \neq c \cap \Xi' \neq c.$$

Now, consider the subgraph Ξ' of Ξ generated by $\cup_j (\cup \mathcal{F}'_j)$; by assumption, no cycle in $\cup_j \mathcal{F}_j$ or in $\cup_j C_{\mathcal{F}'_j}$ is in the condition just described. Thus the associated sub-pseudomanifold P has empty boundary and has the same dimension as Σ : which contradicts a standard consequence of Alexander's Duality Theorem.

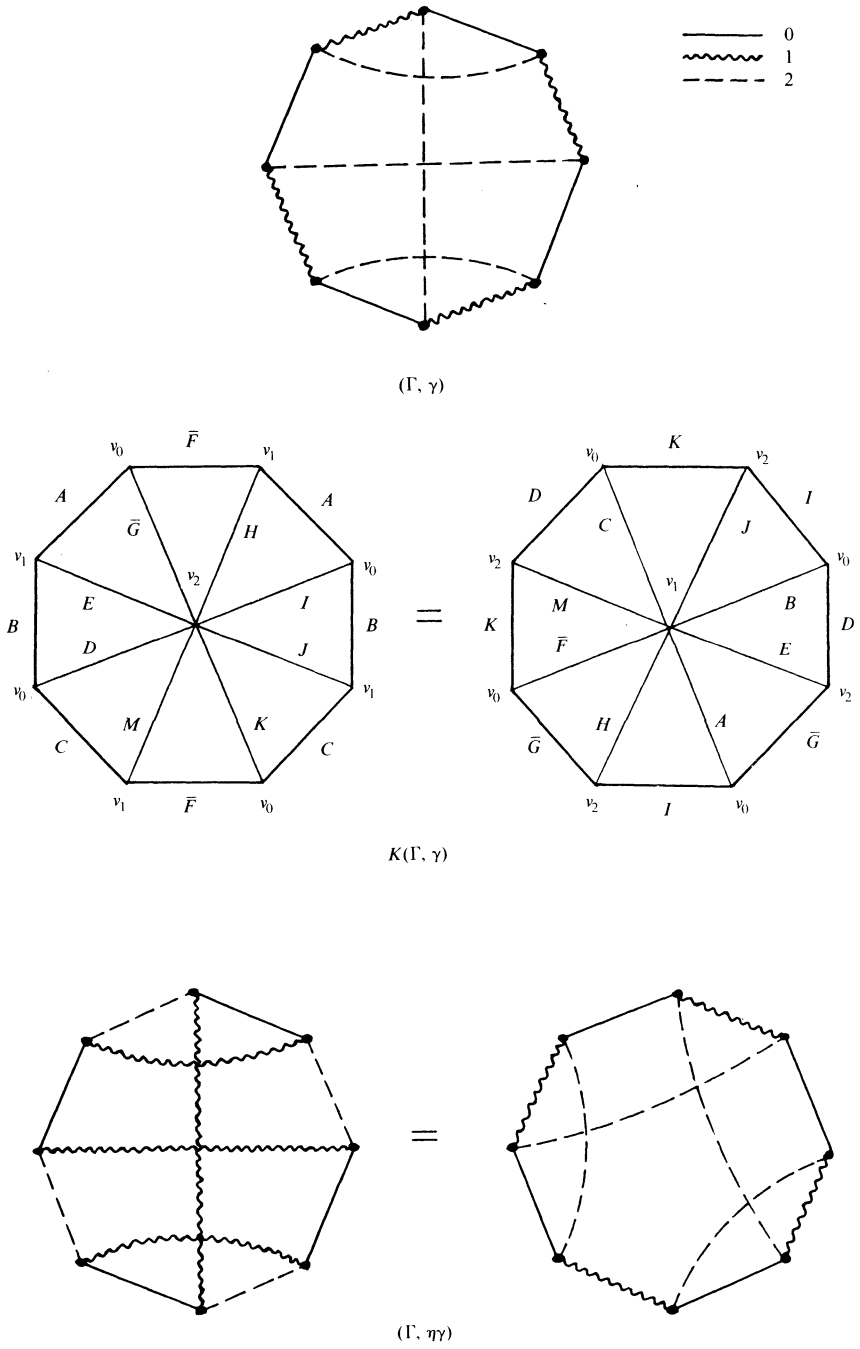

Figure 3a

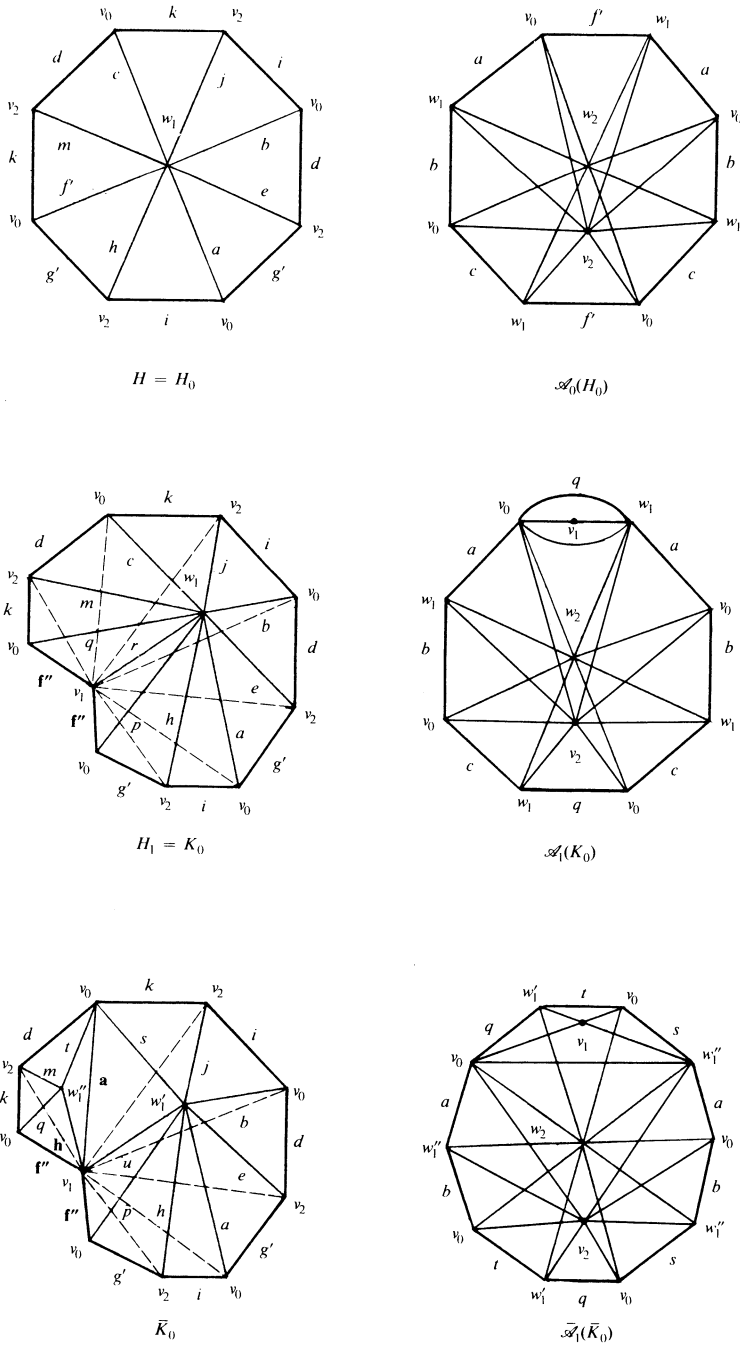

Figure 3b

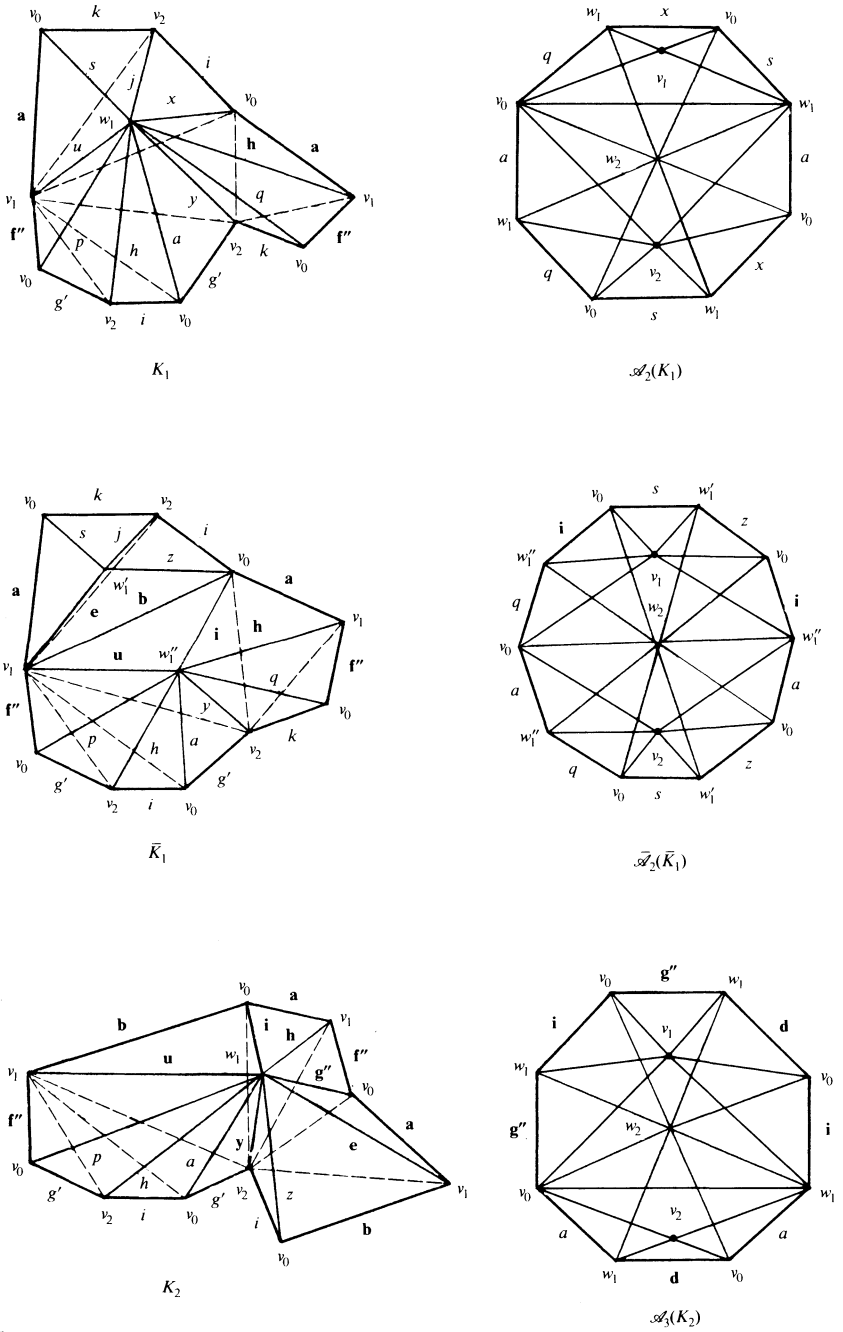

Figure 3b

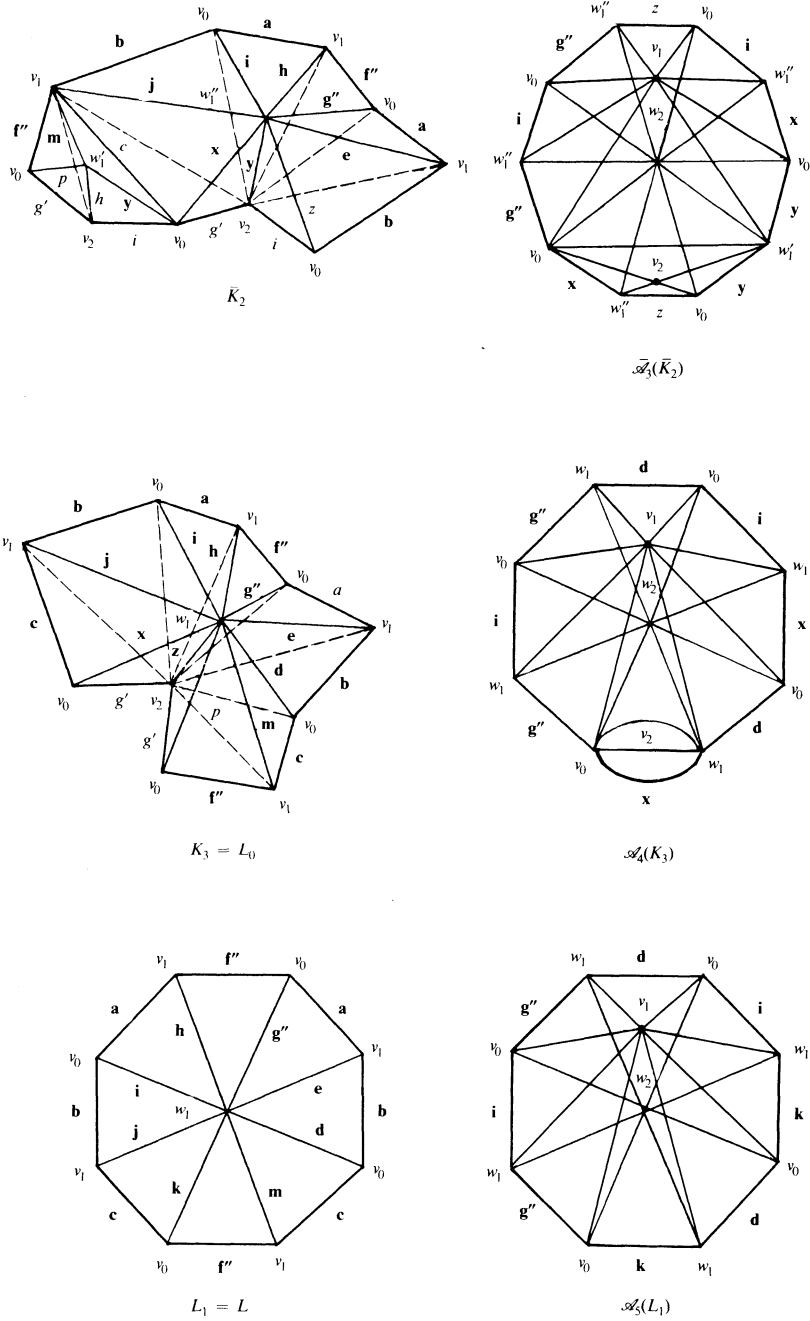

Figure 3b

5. Proof of the switching lemma. The proof will be followed more easily by checking it on Figure 3, relative to (a) a crystallization and the related contracted triangulation of the nonorientable surface of genus 3, (b) the whole process in \mathbb{C}^2 (left) and \mathbb{C}^3 (right), and (c) the sequence of moves. Of course, this example does not illustrate the part concerning nondegenerate dipoles, therefore a further example of application of the lemma is given in Figure 4, relative to a crystallization of $L(3, 1)$; here the nondegenerate dipoles come from the cleft of Figure 2, and from a similar cleft performed on the graph obtained from $\Gamma_{\hat{3}}$.

Proof. Without loss of generality, let $r = n - 1, s = n$. The complex $K = K(\Gamma, \gamma)$ has cone-vertices v_0, \dots, v_n , and so

$$(K, \{v_i|i \in \Delta_n\}) \in \mathbb{C}^{n+1}.$$

Consider, instead,

$$(K, \{v_i|i \in \Delta_{n-2}\}) \in \mathbb{C}^{n-1}.$$

Further, K is called H after v_{n-1} is renamed w_{n-1} and this also is considered to be a cone-vertex, i.e.,

$$(H, \{v_i|i \in \Delta_{n-2}\} \cup \{w_{n-1}\}) \in \mathbb{C}^n.$$

Analogously, K is called L after v_n is renamed w_{n-1} , and

$$(L, \{v_i|i \in \Delta_{n-2}\} \cup \{w_{n-1}\}) \in \mathbb{C}^n.$$

By Proposition 6, there exists a v_{n-1} -centered cone-algorithm \mathcal{A}' and a v_n -centered one \mathcal{A}'' , both on K , such that $\mathcal{A}'(K)$ and $\mathcal{A}''(K)$ can be obtained from H and L respectively by adding a dipole of type n , and a set of nondegenerate dipoles, all involving w_{n-1} . The two n -dipoles can be arbitrarily placed; therefore choose an n -simplex $s \in K$: the facet of s opposite to v_n is called \bar{f} , and the facet of s opposite to v_{n-1} is called \bar{g} ; to \bar{f} (resp. to \bar{g}) there corresponds f' in H (resp. g'' in L). Choose the n -dipoles to be added in H and L , so that they double f' and g'' respectively; note that \bar{f}, f' are the same simplex, with differently named vertices, and similarly \bar{g}, g'' .

By Remark 1, $\mathcal{A}''(K)$ can be obtained from $\mathcal{A}'(K)$ by a sequence of cut-and-glues involving w_{n-1} . Each cut is made along a facet with vertices v_0, \dots, v_{n-1} and each glueing along a facet with vertices v_0, \dots, v_{n-2}, v_n . Let D', D'' be the n -balls associated with $\mathcal{A}', \mathcal{A}''$ respectively: By the previous choice, \bar{f} is on $\partial D'$ and \bar{g} is on $\partial D''$, so that no cut (resp. no glueing) is made along f' (resp. g'').

To resume, there is a sequence

$$\begin{aligned} H &= H_0, \dots, H_l = \mathcal{A}'(K) = K_0, \dots \\ \dots, K_k &= \mathcal{A}''(K) = L_0, \dots, L_m = L, \end{aligned}$$

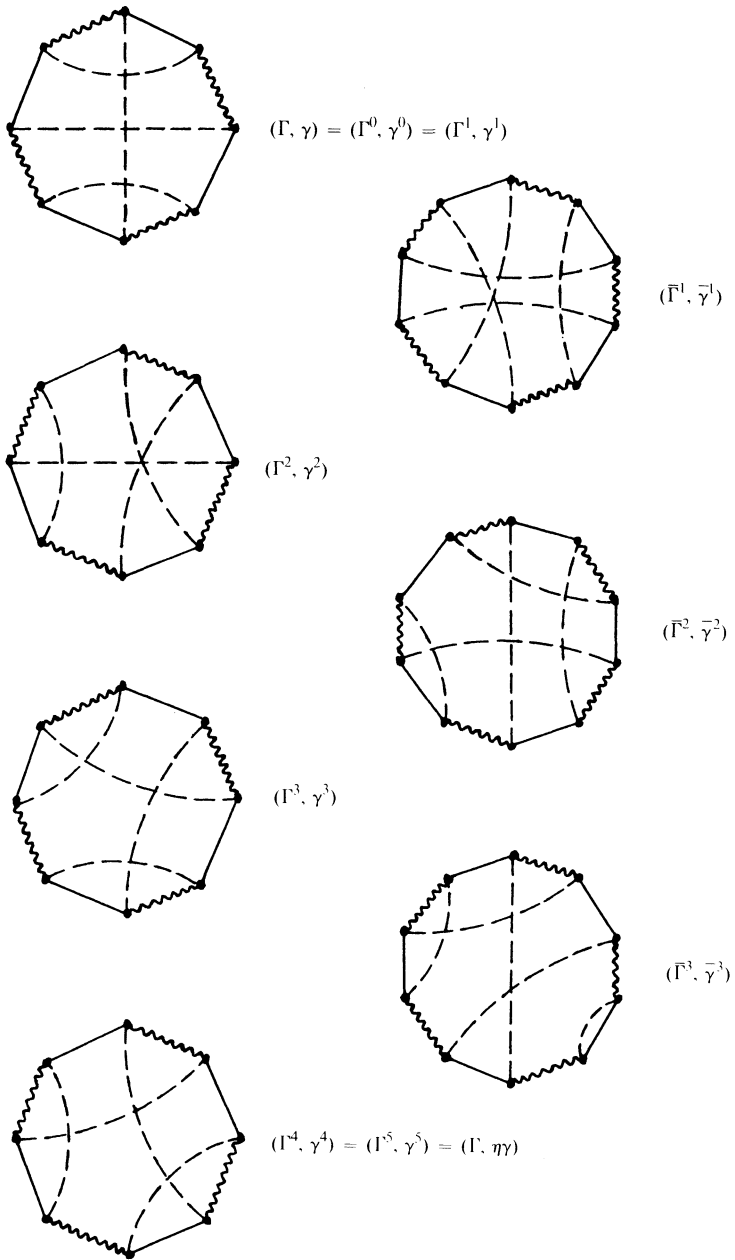

Figure 3c

in which H_1 (resp. L_m) is obtained from H_0 (resp. from L_{m-1}) by adding (resp. cancelling) a dipole of type n , H_{i+1} (resp. L_i) from H_i (resp. from L_{i-1}) by adding (resp. cancelling) a nondegenerate dipole for all $i \in \mathbf{N}_{l-1}$ (resp. $i \in \mathbf{N}_{m-1}$), and K_i is obtained from K_{i-1} by a cut-and-glue for all $i \in \mathbf{N}_k$, all dipoles and cut-and-glues involving w_{n-1} .

Now, we want to pass to \mathbb{C}^{n+1} by new cone-algorithms, which introduce a new cone-vertex w_n . Observe that there are only two non-cone-vertices, namely v_{n-1} and v_n , so only two disjoint stars are required to be attached together through a facet, when forming the balls of the cone-algorithms.

In order to define a cone-algorithm \mathcal{A}_l on $H_l = K_0$, choose the attaching facet (necessarily with vertices $w_{n-1}, v_0, \dots, v_{n-2}$) to be that of the n -simplex $s' = w_{n-1} * g'$ (the facet in question takes the place of f' ; e.g. in Figure 3 it is p). But since g' cannot be the meet-facet of the next glueing, \mathcal{A}_l satisfies condition (*) of the proof of Lemma 4d (see Remark 4). Then a single cut-and-glue, involving w_{n-1} , joins $\mathcal{A}_l(K_0)$ to an $\mathcal{A}_{l+1}(K_1)$, where \mathcal{A}_{l+1} satisfies the same condition. For the same reason, there is a cone-algorithm \mathcal{A}_{l+i} , for each $i \in \mathbf{N}_k$, such that $\mathcal{A}_{l+i}(K_i)$ is obtained from $\mathcal{A}_{l+i-1}(K_{i-1})$ by a cut-and-glue involving w_{n-1} .

The same choice of the attachment facet grants also that condition (\$) of Lemma 4c, Case 2 is satisfied for \mathcal{A}_l and for the dipole whose cancellation yields H_{l-1} out of H_l . Remark 3 then assures the existence of a cone-algorithm \mathcal{A}_{l-1} on H_{l-1} satisfying the same condition, and such that $\mathcal{A}_{l-1}(H_{l-1})$ is obtained from $\mathcal{A}_l(H_l)$ by cancelling a nondegenerate dipole involving w_{n-1} , but not involving w_n . The argument applies also for $\mathcal{A}_{l+k}, L_0, L_1$; moreover, it can be repeated inductively. Then, having defined an \mathcal{A}_{j+1} on H_{j+1} , with $j \in \mathbf{N}_{l-1}$ (resp. an $\mathcal{A}_{l+k+j-1}$ on L_{j-1} , with $j \in \mathbf{N}_{m-1}$), there exists an \mathcal{A}_j on H_j (resp. an \mathcal{A}_{l+k+j} on L_j) such that $\mathcal{A}_j(H_j)$ (resp. $\mathcal{A}_{l+k+j}(L_j)$) is obtained from $\mathcal{A}_{j+1}(H_{j+1})$ (resp. from $\mathcal{A}_{l+k+j-1}(L_{j-1})$) by cancelling a nondegenerate dipole which involves w_{n-1} but does not involve w_n .

All complexes of the last built sequence are contracted, and have cone-vertices $v_0, \dots, v_{n-2}, w_{n-1}, w_n$; to the complex yielded by \mathcal{A}_t , with $t \in \Delta_{l+k+m}$, there corresponds a crystallization (Γ^t, γ^t) of M , in which the colours are chosen accordingly with the subscripts of the cone-vertices. Of course, (Γ^t, γ^t) is obtained from $(\Gamma^{t-1}, \gamma^{t-1})$ (for each $t \in \mathbf{N}_{l+k+m}$) either by no moves, or by moves of type I involving colour $n - 1$, or by moves of type II involving colour $n - 1$ and not involving colour n .

Observe, now, that $\mathcal{A}_0(H_0)$ is isomorphic with K by an isomorphism in which w_{n-1} corresponds to v_{n-1} and w_n to v_n ; also $\mathcal{A}_{l+k+m}(L_m)$ is necessarily isomorphic with K , but by an isomorphism which maps w_{n-1} to v_n and w_n to v_{n-1} . But then

$$(\Gamma^0, \gamma^0) = (\Gamma, \gamma) \quad \text{and} \quad (\Gamma^{l+k+m}, \gamma^{l+k+m}) = (\Gamma, \eta\gamma),$$

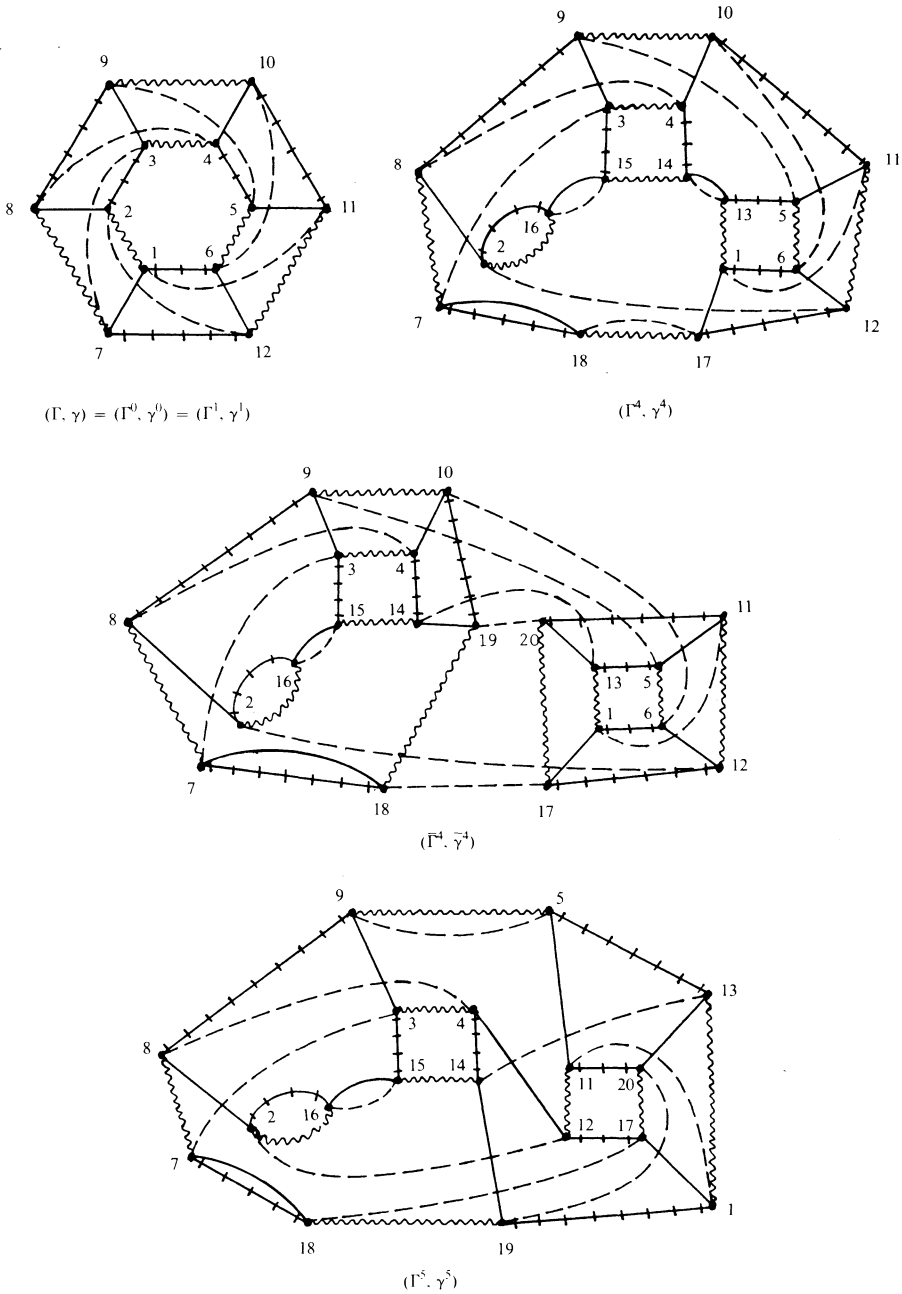

Figure 4

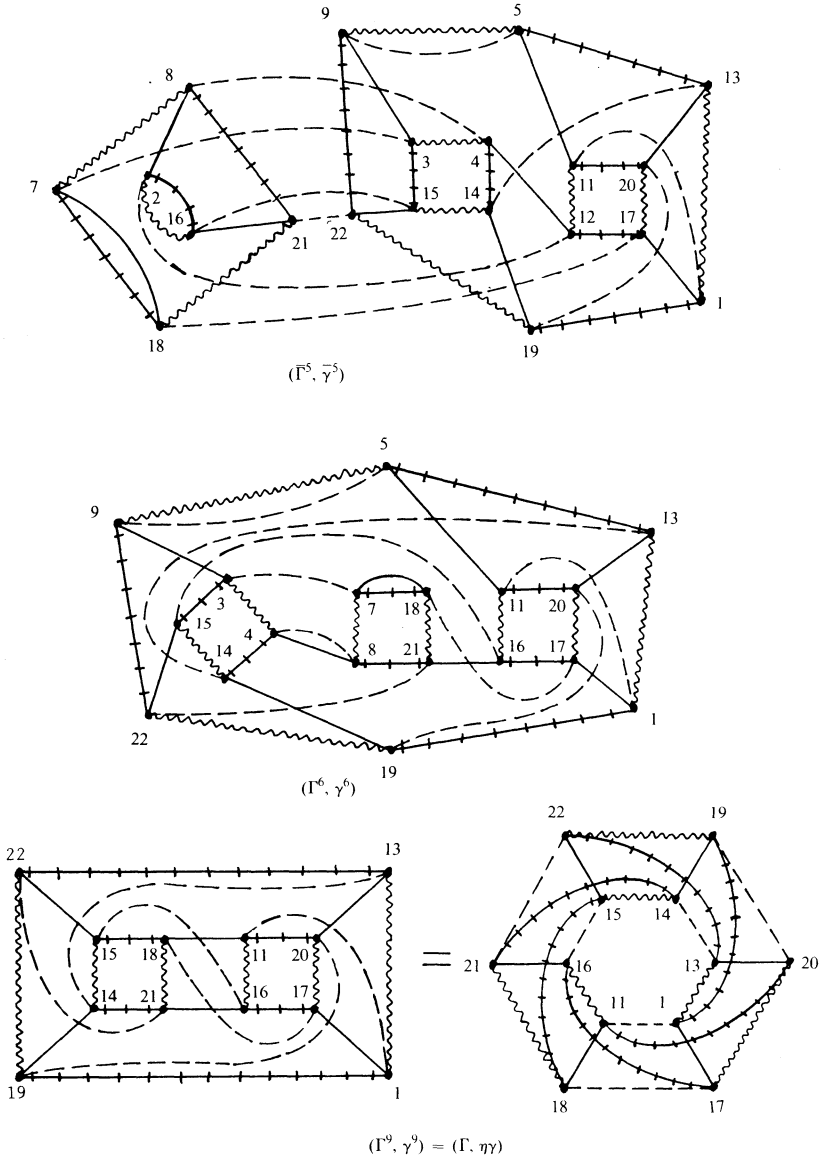

Figure 4

and this proves the statement.

Remark 6. Note that exactly one edge coloured $n - 1$ (in the notation of the preceding proof) is preserved during the process, i.e., neither of its end-points is part of an added or cancelled dipole. This is the edge which corresponds to the facet of the first incision of $\text{std}(w_{n-1}, L)$, i.e., the one doubled by the introduction of an n -dipole (at level \mathfrak{G}^n , and so without generation of dipoles at level \mathfrak{G}^{n+1}).

In fact, all other facets, corresponding to edges coloured $n - 1$, are affected either by the incisions necessary to the formation of the v_n -centered cone-algorithm \mathcal{A}'' , or by the cut-and-glues. Since all dipoles of the sequence involve colour $n - 1$, none of them may contain an end-point of that edge.

Finally, note that the edge to be preserved can be arbitrarily chosen before starting the process.

6. Proof of theorem 1.

Proof. If (Γ, γ) and (Γ', γ') are joined by a sequence of moves (no matter whether involving colour l or not) they obviously represent the same manifold; so (2) \Rightarrow (1) and (3) \Rightarrow (1). Now, in order to reverse these implications, recall that the homeomorphism of M and M' always implies that (Γ', γ') is obtained from (Γ, γ) by a finite sequence of moves of type I and II, from the already quoted theorem of [3].

To prove that (1) \Rightarrow (2) (resp. (1) \Rightarrow (3)) it suffices to consider a (Γ', γ') obtained from (Γ, γ) by a single move not involving (resp. involving) colour l . The move in question involves (resp. does not involve) at least one colour $m \neq l$. Then, if η is the permutation of Δ_n which interchanges l with m , $(\Gamma', \eta\gamma')$ is obtained from $(\Gamma, \eta\gamma)$ by the same move, which now involves (resp. does not involve) colour l . By the Switching Lemma, applied to the pairs (Γ, γ) , $(\Gamma, \eta\gamma)$ and $(\Gamma', \eta\gamma')$, (Γ', γ') with $r = l, s = m$ (resp. $r = m, s = l$), (Γ', γ') is obtained from (Γ, γ) by a sequence of moves involving (resp. not involving) colour l .

Remark 7. A generalization (in fact a trivial consequence) of the equivalence theorem of [3] is that, if two $(n + 1)$ -coloured graphs (Γ, γ) , (Γ', γ') represent n -manifolds M, M' respectively, then M and M' are homeomorphic if and only if (Γ, γ) and (Γ', γ') are obtained from each other by a finite sequence of addings and/or cancellings of dipoles of type $h \leq n - 1$.

For if one or either graph is not contracted, a finite sequence of eliminations of 1-dipoles makes it into a crystallization; therefore the equivalence theorem applies. This suggests a similar extension of Theorem 1 to noncontracted graphs; but the 1-dipoles to be cancelled may involve different (hence even all) colours, and, on the other hand, the techniques

developed here are specific for crystallizations. So it is an open problem, whether such an extension holds.

REFERENCES

1. M. Ferri, *Una rappresentazione delle n -varietà topologiche triangolabili mediante grafi $(n + 1)$ -colorati*, Boll. Un. Mat. Ital. 13 B (1976), 250-260.
2. ——— *Crystallisations of 2-fold branched coverings of S^3* , Proc. Amer. Math. Soc. 73 (1979), 271-276.
3. M. Ferri and C. Gagliardi, *Crystallisation moves*, Pacific J. Math. 100 (1982), 85-103.
4. ——— *The only genus zero n -manifold is S^n* , Proc. Amer. Math. Soc. 85 (1982), 638-642.
5. ——— *On the genus of 4-dimensional products of manifolds*, Geom. Dedicata 13 (1982), 331-345.
6. M. Ferri, C. Gagliardi and L. Grasselli, *A graph-theoretical representation of PL-manifolds – A survey on crystallizations*, Aequationes Math. 31 (1986), 121-141.
7. C. Gagliardi, *Regular imbeddings of edge-coloured graphs*, Geom. Dedicata 11 (1981), 397-414.
8. ——— *Extending the concept of genus to dimension n* , Proc. Amer. Math. Soc. 81 (1981), 473-481.
9. F. Harary, *Graph theory* (Addison Wesley, 1968).
10. P. J. Hilton and S. Wylie, *An introduction to algebraic topology – Homology theory*, (Cambridge University Press, 1960).
11. R. Kirby, *Problems in low-dimensional manifold theory*, Proc. Symp. Pure Math. 32 (1978), 273-312.
12. S. Lins, *Graphs of maps*, Ph. D. Thesis, University of Waterloo (1980).
13. ——— *Graph-encoded maps*, J. Combin. Theory Ser. B 32 (1982), 171-181.
14. S. Lins and A. Mandel, *Graph-encoded 3-manifolds*, Discrete Math. 57 (1985), 261-284.
15. M. Pezzana, *Sulla struttura topologica delle varietà compatte*, Atti Sem. Mat. Fis. Univ. Modena 23 (1974), 278-285.
16. ——— *Diagrammi di Heegaard e triangolazione contratta*, Boll. Un. Mat. Ital. 12, Suppl. fasc. 3 (1975), 98-105.
17. C. Rourke and B. Sanderson, *Introduction to piecewise-linear topology* (Springer Verlag, 1972).
18. A. Vince, *Graphic matroids, shellability and the Poincaré conjecture*, Geom. Dedicata 14 (1983), 303-314.

*Universita di Bologna,
Bologna, Italia*