

A NUMERICAL METHOD OF INFERRING THE BUDGET HISTORY OF A GLACIER FROM ITS ADVANCE AND RETREAT

By J. F. NYE

(H. H. Wills Physics Laboratory, University of Bristol, Bristol, England)*

ABSTRACT. The paper considers how to calculate the budget history of a glacier from the historical record of its advance and retreat. The linearized differential equations developed in previous papers are used to compute a series of coefficients $g(n)$. The $g(n)$ operate directly on a record of annually spaced observations of the position of the glacier terminus, to give the time variation of net budget. The $g(n)$ are calculated for South Cascade Glacier, Washington, U.S.A. and for Storglaciären, Kebnekaise, Sweden, and are applied to the terminus records of these two glaciers. The results indicate that the figures for the retreat during individual years are not sufficiently reliable to deduce annual net budget changes with confidence. But the coarser features of the terminus records give net budget figures that agree well with the 9 yr. or 10 yr. means of recent observations. The theory extends the generalized budget record of Storglaciären back by several decades, and shows an increase in net budget in the 1930's that is not immediately apparent in the terminus record.

RÉSUMÉ. Méthode numérique pour déduire l'histoire du bilan d'un glacier de son avance et retrait. Ce travail donne la manière de calculer l'histoire du bilan d'un glacier à partir des données historiques de son avance et de son retrait. Les équations différentielles linéarisées dans des publications antérieures sont utilisées pour déterminer une série de coefficients $g(n)$. Les $g(n)$ opèrent directement sur les données d'observations annuelles de la position du front du glacier pour donner la variation de temps du bilan net. Les $g(n)$ sont calculés pour le South Cascade Glacier, Washington, U.S.A. et pour le Storglaciären, Kebnekaise, Suède, et sont appliqués aux observations des fronts de ces deux glaciers. Les résultats montrent que les valeurs du retrait pendant des années individuelles ne sont pas suffisamment valables pour en déduire les variations annuelles du bilan net avec certitude. Mais des aspects plus généraux des observations des fronts donnent des valeurs du bilan qui correspondent bien aux moyennes des données récentes de neuf ou dix années. La théorie étend l'observation du bilan général du Storglaciären en arrière de plusieurs décades, et montre une augmentation du bilan net vers 1933, ce qui n'apparaît pas immédiatement des observations du front.

ZUSAMMENFASSUNG. Eine numerische Methode zur Ermittlung der Haushaltsgeschichte eines Gletschers aus seinen Vorstößen und Rückzügen. Die Arbeit untersucht die Möglichkeiten zur Berechnung der Haushaltsgeschichte eines Gletschers aus den historischen Aufzeichnungen seiner Vorstöße und Rückzüge. Die linearisierten Differentialgleichungen, die in früheren Veröffentlichungen aufgestellt wurden, werden zur Berechnung einer Reihe von Koeffizienten $g(n)$ herangezogen. Die $g(n)$ ergeben in Verbindung mit einer Liste von jährlichen Beobachtungen der Lage des Gletscherendes unmittelbar die zeitliche Veränderung des Netto-Haushaltes. Die $g(n)$ werden für den South Cascade Glacier, Washington, USA, und für den Storglaciären, Kebnekaise, Schweden, berechnet und auf die Zungenbeobachtungen an diesen beiden Gletschern angewandt. Die Ergebnisse zeigen, dass die Zahlenwerte für den Rückzug in einzelnen Jahren nicht zuverlässig genug sind, um daraus gesicherte jährliche Haushaltsänderungen ableiten zu können. Doch liefert der gröbere Verlauf der Zungenbeobachtungen Netto-Haushaltswerte, die gut mit den Mitteln der 9- bzw. 10-jährigen Beobachtungen übereinstimmen. Die Theorie führt die allgemeinen Haushaltsaufzeichnungen am Storglaciären um einige Jahrzehnte zurück und weist eine Erhöhung des Netto-Haushaltes in den 30er Jahren nach, die aus den Zungenbeobachtungen nicht unmittelbar ersichtlich ist.

1. INTRODUCTION

A theoretical treatment has been given in other papers (Nye, 1960, 1963[a], 1963[b], 1965) referred to as Nye [I], Nye [II], Nye [III] and Nye [IV] respectively, of the relation between the fluctuations of accumulation and ablation on a glacier and the associated fluctuations of the glacier itself. As a matter of history, while the variations in accumulation and ablation on glaciers have only been systematically measured since about 1945 the records of the changes in length go back in some cases for 300 yr. The geomorphological record of course goes back, with less detail, into the Pleistocene. The possibility therefore presents itself of taking the known records of changes in length of the glaciers and trying to infer the changes of accumulation and ablation that caused them, thereby considerably extending the record

* This work was done while the author was a visitor at the Hammond Metallurgical Laboratory, Yale University, and at the Institute of Geophysics and Planetary Physics, University of California at Los Angeles.

of accumulation–ablation history into the past. The present paper takes the differential equations of the theory as its starting point, and considers how to apply them numerically to deduce the input (accumulation–ablation record) that gave a given output (advance–retreat record). The calculation scheme thus developed is applied to the terminus records of South Cascade Glacier, Washington, U.S.A., and Storglaciären, Kebnekaise, Sweden, since the functions that characterize these two glaciers are known from previous work.

The method described in Nye [III] for solving the same problem, which uses a series of coefficients λ_n , entails first filtering out the high frequencies in the terminus record and then computing time derivatives. By contrast, the method to be described here works directly from the annually spaced observations of the terminus without filtering; it is comparatively simple to apply and is, in general, much better than the earlier method. However, the method using the λ_n series is still useful in theoretical studies where the terminus record is taken as a polynomial in the time t .

2. THE DIFFERENTIAL EQUATIONS

The notation follows that used in the previous papers. x is the distance down the glacier, t is the time. A datum glacier (suffixes 0) is considered in which the accumulation rate (thickness of ice added per unit time) is $a_0(x)$. $a_0(x)$ is negative in the ablation area. A linear perturbation treatment [Nye III] leads to the two simultaneous partial differential equations

$$\frac{\partial \mathbf{q}_1}{\partial x} + B_0(x) \frac{\partial h_1}{\partial t} = B_0(x) a_1(x, t), \quad (1)$$

$$\mathbf{q}_1 = \mathbf{c}_0(x) h_1 - \mathbf{D}_0(x) \frac{\partial h_1}{\partial x}, \quad (2)$$

where $\mathbf{q}_1(x, t)$ is the perturbation in discharge from the steady datum rate, $h_1(x, t)$ is the perturbation in thickness, and $a_1(x, t)$ is the perturbation in accumulation and ablation rate. $B_0(x)$, $\mathbf{c}_0(x)$ and $\mathbf{D}_0(x)$ are fixed functions that characterize the particular glacier. $B_0(x)$ is the datum-state width of the channel, $\mathbf{c}_0(x)/B_0(x)$ is the velocity of kinematic waves of \mathbf{q}_1 down the glacier, and $\mathbf{D}_0(x)/B_0(x)$ is their diffusion coefficient. (1) arises from the equation of continuity, while (2) is a consequence of the assumed nature of the flow process. If \mathbf{q}_1 is eliminated between (1) and (2) we obtain a type of diffusion equation

$$\mathbf{D}_0 \frac{\partial^2 h_1}{\partial x^2} - (\mathbf{c}_0 - \mathbf{D}_0') \frac{\partial h_1}{\partial x} - \mathbf{c}_0' h_1 + B_0 a_1 = B_0 \frac{\partial h_1}{\partial t}, \quad (3)$$

where the primes denote differentiation with respect to x .

We shall mostly be concerned with the case where $a_1(x, t)$ is independent of x , so we simply write it as $a_1(t)$. Thus $a_1(t)$ is the function representing the variation in accumulation rate that we are going to try to deduce. It represents the increase in the accumulation rate or the decrease in the ablation rate from the steady state value $a_0(x)$ at any point on the glacier. Other assumptions about the x dependence of $a_1(x, t)$ could be made, but *some* assumption must be made if the basic problem of deducing budget history from advance–retreat history is to have a solution. Otherwise we should be trying to deduce a function of two variables from a function of only one variable.

The given data, besides the coefficient functions $B_0(x)$, $\mathbf{c}_0(x)$, $\mathbf{D}_0(x)$, could be the time variations of thickness, that is, of h_1 at some fixed point on the glacier. What is more commonly observed, however, is the variation in the position of the end of the glacier. We denote this by $l_1(t)$, measuring l_1 from the end of the datum glacier. l_1 is geometrically related to h_1 at the wedge-shaped end of the datum glacier (fixed at $x = L$) by the equation

$$l_1(t) = h_1(L, t) \operatorname{cosec} \theta, \quad (4)$$

where θ is the angle of the wedge. The problem is then, given $l_1(t)$, to find $h_1(L, t)$ from (4), and then find what source function $a_1(t)$ in (3) will produce the required $h_1(L, t)$.

3. THE USE OF INFLUENCE COEFFICIENTS

The record of $l_1(t)$ and therefore of $h_1(L, t)$ is not, in practice, a continuous one. Observations are commonly made at the end of the ablation season at intervals of one year. One way of filling in the gaps in the record would be to make some assumption about the winter–summer variation between the observed points. If we did this our final result for $a_1(t)$ would include the winter–summer variations. We are not usually interested in these, and in any case they would merely reflect what was assumed for the winter–summer variation of $l_1(t)$. To pursue the same line of thought, the true function $l_1(t)$ includes also very high-frequency detail due to individual snowfalls, hot days and so on, and all this is faithfully reflected in the true variation of $a_1(t)$ by the simple relation

$$\frac{\partial h_1}{\partial t} = a_1.$$

We do not have this detailed record of $h_1(L, t)$, nor do we wish to know the corresponding detail in $a_1(t)$. In this situation we propose to adopt a different way of filling in the gaps in the record.

We consider an artificial function $a_1(t)$ that is constant throughout any one (budget) year. It thus consists of a number of steps (Fig. 1a). The corresponding function $l_1(t)$ consists of a number of nearly straight (more accurately, exponential) segments, with discontinuities in slope (Fig. 1b). The observations are taken to be the points P_1, P_2, P_3, \dots . The method of deducing $a_1(t)$ that we describe is valid when the time $\Delta t = 1$ yr. is sufficiently short to be taken as the time interval in a certain finite difference solution of the equations. Now it could happen that a time interval of 1 yr. was too long for this to be true, but in fact the time constants of glaciers are long enough for the approximation to be a good one. (We verify this later for the individual glaciers treated.) This is a fortunate circumstance for it means that annual observations may be used to infer the step curve of $a_1(t)$. Thus we may say that *if* the real $a_1(t)$ actually followed the step curve (although we know it does not), then the resulting $l_1(t)$ curve would pass through the observed positions. That is the precise meaning of the $a_1(t)$ step curve that we deduce.

To a good approximation this step curve may be taken as the mean over the year of the

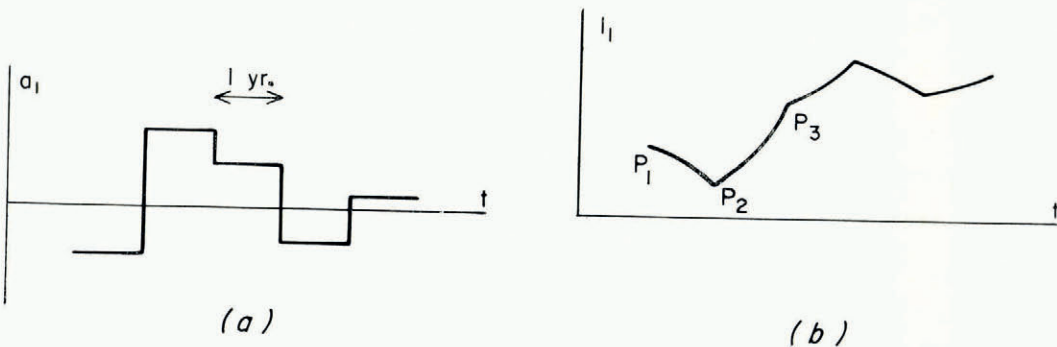

Fig. 1. (a) Assumed step function $a_1(t)$. (b) Resulting response function $l_1(t)$

actual $a_1(t)$ function. This mean is closely connected with what is usually, but wrongly,* called the net budget. The net budget of a glacier at the point x is, in our notation,

$$\int_t^{t+\Delta t} [a_0(x) + a_1(t)] dt = \Delta t [a_0(x) + (\Delta t)^{-1} \int_t^{t+\Delta t} a_1(t) dt],$$

where $\Delta t = 1$ yr. The second term in the right-hand bracket is what we deduce. When added to $a_0(x)$ and multiplied by Δt it gives the net budget of the glacier at the point in question. In short, the step function $a_1(t)$ that we deduce gives the time variation in the net budget of the glacier.

The numerical method to be described comes from a finite difference approximation to the original differential equations. The time derivative $\partial/\partial t$ is replaced by a centred difference using an interval $\Delta t = 1$ yr. This means that the equations contain values of the dependent variables at one-year intervals; in particular, they contain the h_t values at the instants of observation. As we have just noted, $\Delta t = 1$ yr. is short enough for this approach to be feasible.

Let the values of h_t at given x , at intervals Δt , be denoted $h(x, 1), h(x, 2), \dots$, back into the past, beginning at a certain instant shown as R in Figure 2. $h(x, n)$ is thus a continuous function of x but a discrete function of time. The values of q_t are similarly denoted $q(x, 1), q(x, 2), \dots, a_1(t)$, which is now taken as constant over each interval, has values $a(1), a(2), \dots$. Note in Figure 2 that these values are placed at the centres of the intervals. We now assume plausibly that

$$h(x, 1) = e(x, 1) a(1) + e(x, 2) a(2) + e(x, 3) a(3) + \dots, \tag{5}$$

$$h(x, 2) = e(x, 1) a(2) + e(x, 2) a(3) + \dots, \tag{6}$$

$$h(x, 3) = e(x, 1) a(3) + \dots, \text{ etc.}, \tag{7}$$

where $e(x, 1), e(x, 2), \dots$, are *influence coefficients* to be determined. Each $a(n)$ in the past, but not in the future, will have an influence on $h(x, 1)$, and since the equations are linear their effects will be additive. This gives equation (5). Equations (6), (7), etc., make the same statement for $h(x, 2), h(x, 3)$, etc., and, since the theory is concerned with small perturbations, they use the *same* set of coefficients $e(x, n)$.

We shall show in a moment how the $e(x, n)$ may be computed numerically. For a particular x , which could be $x = L$, we write the equations simply as

$$\left. \begin{aligned} h(1) &= e(1) a(1) + e(2) a(2) + e(3) a(3) + \dots \\ h(2) &= e(1) a(2) + e(2) a(3) + \dots \\ h(3) &= e(1) a(3) + \dots \text{ etc.} \end{aligned} \right\} \tag{8}$$

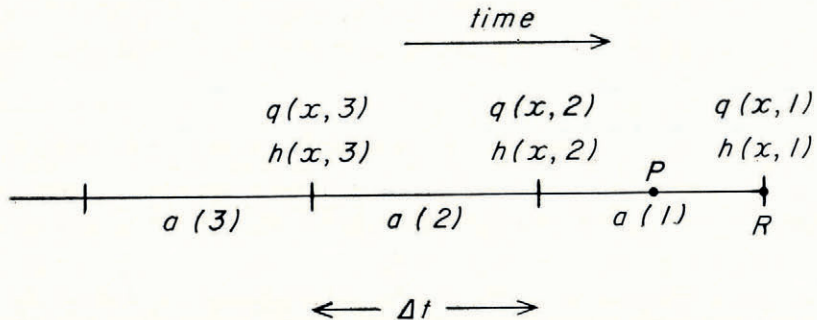

Fig. 2

* In common usage the word budget means an estimate, often itemized, of expected income and expense, or an itemized allotment of funds, for a given period *in the future*. What glaciologists call the net budget is really the annual balance, or the annual surplus or deficit, and would be better so called. Why use an esoteric term when plain ones are to hand?

If these equations are now solved for $a(1), a(2), \dots$, in terms of $h(1), h(2), \dots$, we find

$$\left. \begin{aligned} a(1) &= g(1) h(1) + g(2) h(2) + g(3) h(3) + \dots \\ a(2) &= \qquad \qquad g(1) h(2) + g(2) h(3) + \dots \\ a(3) &= \qquad \qquad \qquad g(1) h(3) + \dots \text{ etc.} \end{aligned} \right\} \quad (9)$$

where the $g(n)$ are a new set of coefficients which, by substitution in (8), satisfy

$$\left. \begin{aligned} g(1) e(1) &= 1 \\ g(1) e(2) + g(2) e(1) &= 0 \\ g(1) e(3) + g(2) e(2) + g(3) e(1) &= 0 \text{ etc.} \end{aligned} \right\} \quad (10)$$

Notice that the matrix of g 's in (9) has the same form as that of the e 's in (8), each row being repeated but displaced by one position.

Equations (10) allow the g 's for a particular x to be found in succession once the e 's are known, by a simple algebraic process. Equations (9) are the result we need for our problem, for they give the sequence $a(1), a(2), \dots$, directly in terms of the observed sequence $h(1), h(2), \dots$.

The g 's are thus our objective, but to calculate them we must first find the e 's. For this purpose first assume a set of equations for the q 's similar to (5), (6), (7), etc.:

$$q(x, 1) = f(x, 1) a(1) + f(x, 2) a(2) + f(x, 3) a(3) + \dots \quad (11)$$

$$q(x, 2) = \qquad \qquad f(x, 1) a(2) + f(x, 2) a(3) + \dots \quad (12)$$

$$q(x, 3) = \qquad \qquad \qquad f(x, 1) a(3) + \dots \text{ etc.} \quad (13)$$

where the $f(x, n)$ are influence coefficients for q . Now write the original differential equation (1) for the point P in Figure 2 and replace $\partial h_1 / \partial t$ by $\{h(x, 1) - h(x, 2)\} / \Delta t$. Approximate $\partial q_1 / \partial x$ at P by

$$\begin{aligned} & \frac{1}{2} \{q'(x, 1) + q'(x, 2)\} \\ &= \frac{1}{2} f'(x, 1) a(1) + \frac{1}{2} \{f'(x, 2) + f'(x, 1)\} a(2) + \dots, \end{aligned}$$

where the primes denote differentiation with respect to x . If we now substitute into equation (1), using (5) and (6), and equate coefficients of $a(1), a(2), \dots$, we obtain*

$$\left. \begin{aligned} f'(x, 1) + K(x) e(x, 1) &= 2B_0(x) \\ f'(x, 2) + K(x) e(x, 2) &= -f'(x, 1) + K(x) e(x, 1) \\ f'(x, 3) + K(x) e(x, 3) &= -f'(x, 2) + K(x) e(x, 2) \text{ etc.} \end{aligned} \right\} \quad (14)$$

where $K(x) = 2B_0(x) / \Delta t$. (14) is thus a finite difference approximation to the original differential equation (1).

Now write the original differential equation (2) for the point R (not P) in Figure 2, substitute from (5) and (11), and equate coefficients of $a(1), a(2), \dots$, to obtain

$$\left. \begin{aligned} f(x, 1) &= c_0(x) e(x, 1) - D_0(x) e'(x, 1) \\ f(x, 2) &= c_0(x) e(x, 2) - D_0(x) e'(x, 2) \\ f(x, 3) &= c_0(x) e(x, 3) - D_0(x) e'(x, 3) \text{ etc.} \end{aligned} \right\} \quad (15)$$

Remembering that all quantities are functions of x and dropping the x 's for brevity, the systems of equations (14) and (15) may be written

* If we assume that, instead of a_i being a function of t only, it can be expressed as $a_i(x, t) = X(x) \bar{a}(t)$, where $X(x)$ is a known function, the only difference is that the right-hand side of the first of equations (14) is $2B_0(x)X(x)$ instead of $2B_0(x)$.

$$\left. \begin{aligned} f'(1) + Ke(1) &= Z(1) \\ f'(2) + Ke(2) &= Z(2) \\ f'(3) + Ke(3) &= Z(3) \text{ etc.} \end{aligned} \right\}, \left. \begin{aligned} f(1) &= c_0 e(1) - D_0 e'(1) \\ f(2) &= c_0 e(2) - D_0 e'(2) \\ f(3) &= c_0 e(3) - D_0 e'(3) \end{aligned} \right\} \text{ etc.} \quad (16)$$

where the $Z(n)$, which are functions of x , are given by the recurrence formulae

$$\left. \begin{aligned} Z(1) &= 2B_0 \\ Z(n) &= 2Ke(n-1) - Z(n-1) \quad (n \geq 2) \end{aligned} \right\}. \quad (17)$$

More compactly we may write (16) as

$$\left. \begin{aligned} f'(n) + Ke(n) &= Z(n) \\ f(n) &= c_0 e(n) - D_0 e'(n) \end{aligned} \right\} \quad (n \geq 1). \quad (18)$$

Eliminating $f(n)$ gives the alternative form

$$D_0 e''(n) - (c_0 - D_0') e'(n) - (c_0' + K) e(n) = -Z(n). \quad (19)$$

Starting with $n = 1$ we therefore have a second-order ordinary differential equation to solve for $e(x, 1)$. When this has been done $Z(2)$ may be found from (17), and then (19) with $n = 2$ gives an equation to solve for $e(x, 2)$, and so on. Thus the influence coefficients $e(x, 1)$, $e(x, 2)$, ..., may be computed in succession.

The nature of the above process is made clearer if we notice the physical interpretation of the $e(x, n)$ coefficients. If all the a 's are zero except for a single one, say $a(r)$, which is equal to 1, equation (5) shows that $h(x, 1) = e(x, r)$. Thus $e(x, r)$ is the h_1 response at time 1 to a unit pulse $a(r)$. If a unit pulse of a_1 occurs as shown in Figure 3, the response $h_1(t)$ at given x will be a certain curve. The height of the curve at time $r\Delta t$ from the beginning of the pulse is $e(x, r)$. In short, the sequence $e(x, n)$ represents the h_1 response at intervals Δt to a unit pulse of a_1 . Similarly the sequence $f(x, n)$ represents the impulse response of q_1 .

The same interpretation follows in the continuous case ($\Delta t \rightarrow 0$). Here, by analogy with (5) we should write the integral equation

$$h_1(x, t) = \int_0^{\infty} e(x, \tau) a_1(t - \tau) d\tau. \quad (20)$$

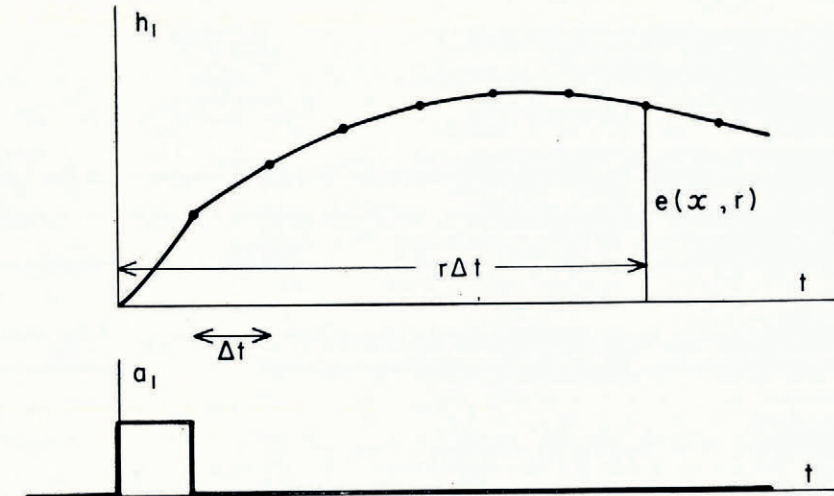

Fig. 3. Interpretation of the influence coefficients $e(x, r)$ as the response to a unit pulse

If we apply a unit pulse (Dirac δ -function) of a_t at time $t-t_0$, the only contribution to the integral comes from $\tau = t_0$, and we obtain

$$h_t(x, t) = e(x, t_0).$$

Thus $e(x, t_0)$ is the response h_t at time t to a unit pulse that occurred at time $t-t_0$. Similarly for f .

Accordingly, if we wished to find the continuous function $e(x, \tau)$ we should try to solve equations (1) and (2) for an impulse of a , occurring at time $t = 0$, say. Hence we should wish to solve the equations

$$\left. \begin{aligned} \frac{\partial f}{\partial x} + B_0 \frac{\partial e}{\partial t} &= B_0 a_t \\ f &= \mathbf{c}_0 e - \mathbf{D}_0 \frac{\partial e}{\partial x} \end{aligned} \right\}$$

for initial condition $e = f = 0$, where we have simply put e for h_t and f for \mathbf{q}_t in (1) and (2).

Now our equations (18) are merely a finite difference form of this pair of equations. If a rectangular pulse of unit height is placed in the first interval (Fig. 3) and if $\partial f/\partial x$ is approximated by $\frac{1}{2}\{f'(n) + f'(n-1)\}$ and $\partial e/\partial t$ by $\{e(n) - e(n-1)\}/\Delta t$, equations (18) are readily derived. What we are doing therefore is nothing more than solving the diffusion equation (3) in finite difference form, with time interval Δt , for a rectangular pulse of a_t of unit height and duration Δt .

So far only t has been put in discrete steps, not x . If, however, we write the simplest type of central difference for the x derivatives in (18) we find we have precisely the Crank-Nicholson scheme for integration of the diffusion equation (Crank and Nicholson, 1947; Richtmyer, 1957, p. 93). This is in fact the scheme we have used.

4. BOUNDARY CONDITIONS

It was shown [Nye II, III] that the functions $B_0(x)$, $\mathbf{c}_0(x)$, $\mathbf{D}_0(x)$ that characterize the glacier may be taken to have the following behaviour at $x = 0$ and $x = L$, the end points of the datum glacier: near $x = 0$, B_0 non-zero, $\mathbf{c}_0 \sim x$, $\mathbf{D}_0 \sim x^2$; near $x = L$, B_0 non-zero, \mathbf{c}_0 non-zero, $\mathbf{D}_0 \sim L-x$. The simultaneous equations (18) for a given n then have the same form as those studied in appendix I of Nye [IV], with e and f substituted for H and Q . From this previous work we know that a unique solution is determined if we require as boundary conditions that e be not infinite at either $x = 0$ or $x = L$. This condition at $x = 0$ is equivalent to the condition $f = 0$. The boundary condition at $x = 0$ gives a one-parameter set of solutions which all have the same leading term, namely

$$e(0, n) = \frac{\mathcal{Z}(n)}{\mathbf{c}'_0 + K} \quad (x = 0), \tag{21}$$

$\mathcal{Z}(n)$, \mathbf{c}'_0 and K all being evaluated at $x = 0$. (If the first two terms in (19) are set equal to zero this form is obtained at once.) At $x = L$ the boundary condition also determines a one-parameter set of solutions, but here the leading term is an arbitrary constant. For all members of this one-parameter family

$$(\mathbf{c}_0 - \mathbf{D}'_0) e'(L, n) + (\mathbf{c}'_0 + K) e(L, n) = \mathcal{Z}(n) \quad (x = L), \tag{22}$$

\mathbf{c}_0 , \mathbf{D}'_0 , \mathbf{c}'_0 , K and $\mathcal{Z}(n)$ all being evaluated at $x = L$. (This form is obtained by setting the first term of (19) equal to zero.) The justification for these assertions about the behaviour at the end points is given in appendix I of Nye [IV].

To summarize, at $x = 0$ we have a simple condition on e , namely (21); while at $x = L$ we have a condition involving a linear combination of e and e' , namely (22).

5. SOLVING THE FINITE DIFFERENCE EQUATION

Points on the x axis are numbered backwards from $j = 1$ ($x = L$) to $j = J$ ($x = 0$) at intervals Δx . In finite difference form equation (19) at any given n is then

$$-A_j e_{j+1} + B_j e_j - C_j e_{j-1} = -\zeta_j \quad (j = 2, 3 \dots J-1) \tag{23}$$

where

$$\begin{aligned} A_j &= -a_j - \gamma_j, & a_j &= (\mathbf{D}_0)_j / (\Delta x)^2, \\ B_j &= -2a_j - \mathcal{N}_j, & \gamma_j &= V_j / 2 \Delta x, \\ C_j &= -a_j + \gamma_j, & \mathcal{N}_j &= (\mathbf{c}'_0 + K)_j, \\ & & V_j &= (\mathbf{c}_0 - \mathbf{D}'_0)_j. \end{aligned}$$

Thus the coefficients A_j , B_j and C_j in (23) may be computed once and for all; they do not depend on n .

The boundary conditions give, from (21),

$$e_J = \frac{\zeta_J}{(\mathbf{c}'_0)_J + K_J} \tag{24}$$

and from (22)

$$e_1 = \frac{V_1}{V_1 + \mathcal{N}_1 \Delta x} e_2 + \frac{\zeta_1 \Delta x}{V_1 + \mathcal{N}_1 \Delta x} \tag{25}$$

To solve the second-order difference equation (23) directly we should need to know two starting values at one end. Instead we have one condition at each end. This boundary value problem is easily dealt with by the method described by Richtmyer (1957, p. 103-04).

We discuss the one-parameter family of solutions S satisfying the boundary condition at $x = L$ ($j = 1$). They will satisfy a certain first-order difference equation, say

$$e_j = E_j e_{j+1} + F_j, \quad j = 1, 2 \dots J-1, \tag{26}$$

and our problem is to find E_j and F_j so that (26) is true for any member of S . Since both (25) and (26) are true for all members of S , it follows that

$$E_1 = \frac{V_1}{V_1 + \mathcal{N}_1 \Delta x}, \quad F_1 = \frac{\zeta_1 \Delta x}{V_1 + \mathcal{N}_1 \Delta x} \tag{27}$$

By substituting $E_{j-1} e_j + F_{j-1}$ for e_{j-1} in (23) and comparing with (26) we find

$$E_j = \frac{A_j}{B_j - C_j E_{j-1}}, \quad F_j = \frac{C_j F_{j-1} - \zeta_j}{B_j - C_j E_{j-1}}, \quad (j = 2, 3 \dots J-1).$$

Since E_1 and F_1 are now known from (27) these equations allow E_2, E_3, \dots and F_2, F_3, \dots to be computed in succession.

Equation (26) may now be used to compute the e_j in succession, starting with $j = J-1$ and using the value of e_J given by (24). The method is very efficient.

Accordingly, the numerical procedure is to solve equation (19) by the above method for $n = 1$. $\zeta(2)$ is then found from (17) and equation (19) is solved for $n = 2$, and so on. This determines the $e(x, n)$.

Some methods of this sort for solving the diffusion equation by forward integration in time suffer from instability when the time step is too long in comparison with Δx (Richtmyer, 1957, p. 9). However, the Crank-Nicholson method, which we are using, is unconditionally stable. This important result was secured essentially by taking central differences at p in Figure 2 rather than, say, one-sided time differences at r .

We have now described how, from the functions $B_0(x)$, $\mathbf{c}_0(x)$, $\mathbf{D}_0(x)$, the influence coefficients (e_x, n) in equations (5), (6), (7), etc., may be obtained numerically—essentially by forward integration of the diffusion equation in time steps of 1 yr. The next step is to invert the e array by equations (10) and thus obtain the g^2 's. This need only be done for the point x that is of interest, normally $x = L$, the end of the datum glacier. Having found

$g(1), g(2), \dots$, they may be applied directly to a record of the changes in terminus position to deduce the time variation of the net budget.

A check on the values obtained for the $e(n)$ and $g(n)$ may be made by considering the case of a perturbation steady in time. Thus if $a_1(t) = A$ say, h_1 will come to the steady state $H(x)$ say. In the notation of Nye [III] we have

$$H(x) = \mu_0(x) A \quad \text{and} \quad A = \lambda_0(x) H(x) \quad (\lambda_0 = \mu_0^{-1}).$$

In the notation of this paper, we put

$$a(1) = a(2) = \dots = A \quad \text{and} \quad h(1, x) = h(2, x) = \dots = H(x)$$

in equations (8) and (9) to obtain

$$H(x) = A \sum_{n=1}^{\infty} e(n, x) \quad \text{and} \quad A = H(x) \sum_{n=1}^{\infty} g(n, x).$$

Thus

$$\sum_{n=1}^{\infty} e(n, x) = \mu_0(x) \quad \text{and} \quad \sum_{n=1}^{\infty} g(n, x) = \lambda_0(x). \tag{28}$$

If $\mu_0(x)$ and $\lambda_0(x)$ are known by some other method (for example by integration of equations (1) and (2) with $\partial/\partial t = 0$, or from the frequency response at zero frequency) these formulae give a check on the values of $e(n, x)$ and $g(n, x)$.

Interpretations may also be given of the other coefficients μ_1, μ_2, \dots and $\lambda_1, \lambda_2, \dots$ introduced in Nye [III]. For example, take the series

$$a_1(t) = \lambda_0 h_1(t) + \lambda_1 \dot{h}_1(t) + \lambda_2 \ddot{h}_1(t) + \dots$$

and let $h_1 = pt$, where p is a constant. Then, at $t = 0$,

$$a_1 = \lambda_1 p.$$

But by (9) we find for a_1 the expression

$$g(1) \cdot 0 - g(2) \cdot p\Delta t - g(3) \cdot 2p\Delta t - \dots - g(n) \cdot (n-1)p\Delta t - \dots$$

Hence

$$\lambda_1 = -\Delta t \sum_{n=2}^{\infty} (n-1) g(n).$$

In general, by putting $h_1 = pt^m$ we find

$$\lambda_m = \frac{(-\Delta t)^m}{m!} \sum_{n=2}^{\infty} (n-1)^m g(n).$$

A similar equation relates μ_m with the $e(n)$.

A remark about the convergence of the two series (8) and (9) is in place before we proceed to the numerical work. Experience with the response of the special model [Nye II] leads us to expect that the impulse response of a glacier will persist for several hundred years. Thus several hundred $e(n, x)$ will be needed if (8) is to be used. On the other hand, we found [Nye II] that only a much shorter past history of h_1 was needed in calculating a_1 . So we expect that the g series in (9) will converge much more rapidly than the e series in (8). To calculate, say, the first 50 g 's we do not have to calculate more than the first 50 e 's. Even though at $n = 50$ the e 's are still very appreciable, we expect that the g 's will be quite small.

Let us now see how these procedures work out in practice.

6. APPLICATION TO SOUTH CASCADE GLACIER

(i) *Computing the influence coefficients*

The above method for finding the $e(n, x)$ and $g(n, x)$ was programmed for an I.B.M. 709 digital computer. The functions $B_0(x)$, $c_0(x)$, $D_0(x)$ could be read in in tabular form and the programme made linear interpolation as necessary. The range of x was divided into 500 intervals and Δt was taken as 1 yr. The $B_0(x)$, $c_0(x)$, $D_0(x)$ functions for South Cascade Glacier, Washington, U.S.A. have been derived [Nye III] from the field observations of Meier and Tangborn (1965). They gave the values of the $e(n)$ and $g(n)$ at $x = L$ shown in Table I

TABLE I. VALUES OF $e(n)$ AND $g(n)$ FOR SOUTH CASCADE GLACIER AND STORGLACIÄREN

<i>n</i> yr.	South Cascade Glacier		Storglaciären		<i>n</i> yr.	South Cascade Glacier		Storglaciären	
	<i>e</i> (<i>n</i>)	<i>g</i> (<i>n</i>)	<i>e</i> (<i>n</i>)	<i>g</i> (<i>n</i>)		<i>e</i> (<i>n</i>)	<i>g</i> (<i>n</i>)	<i>e</i> (<i>n</i>)	<i>g</i> (<i>n</i>)
1	1.084	0.92241	1.066	0.93815	51	3.044	0.00000	7.085	0.00003
2	1.275	-1.08522	1.205	-1.06046	52	2.962	0.00000	7.070	-0.00002
3	1.517	-0.01425	1.359	0.00296	53	2.881	0.00000	7.050	-0.00006
4	1.808	-0.00235	1.528	0.00343	54	2.801	0.00000	7.025	-0.00010
5	2.129	0.02079	1.714	0.00434	55	2.722	0.00000	6.994	-0.00014
6	2.459	0.04118	1.915	0.00604	56	2.645	0.00000	6.959	-0.00017
7	2.781	0.04997	2.130	0.00852	57	2.569	0.00000	6.919	-0.00020
8	3.084	0.04558	2.356	0.01133	58	2.495	0.00000	6.874	-0.00022
9	3.364	0.03360	2.589	0.01379	59	2.422	0.00000	6.823	-0.00024
10	3.619	0.01989	2.826	0.01539	60	2.350	0.00000	6.768	-0.00024
11	3.849	0.00758	3.063	0.01588	61	2.281	0.00000	6.708	-0.00025
12	4.054	-0.00168	3.299	0.01531	62	2.212	0.00000	6.644	-0.00025
13	4.234	-0.00723	3.531	0.01387	63	2.145	0.00000	6.574	-0.00024
14	4.391	-0.00944	3.757	0.01182	64	2.080	0.00000	6.501	-0.00023
15	4.526	-0.00912	3.977	0.00941	65	2.016	0.00000	6.423	-0.00022
16	4.641	-0.00725	4.189	0.00689	66	1.954	0.00000	6.341	-0.00020
17	4.735	-0.00475	4.393	0.00445	67	1.894	0.00000	6.256	-0.00018
18	4.812	-0.00230	4.589	0.00224	68	1.834	0.00000	6.166	-0.00016
19	4.872	-0.00034	4.777	0.00035	69	1.777	0.00000	6.074	-0.00014
20	4.916	0.00097	4.955	-0.00116	70	1.721	0.00000	5.978	-0.00011
21	4.946	0.00161	5.125	-0.00228	71	1.666	0.00000	5.879	-0.00009
22	4.963	0.00173	5.286	-0.00302	72	1.613	0.00000	5.778	-0.00007
23	4.967	0.00148	5.439	-0.00341	73	1.561	0.00000	5.674	-0.00006
24	4.961	0.00106	5.583	-0.00351	74	1.511	0.00000	5.569	-0.00004
25	4.944	0.00059	5.719	-0.00337	75	1.462	0.00000	5.461	-0.00003
26	4.919	0.00019	5.847	-0.00305	76	1.415	0.00000	5.352	-0.00002
27	4.885	-0.00010	5.967	-0.00261	77	1.369	0.00000	5.241	-0.00001
28	4.843	-0.00027	6.079	-0.00211	78	1.324	0.00000	5.129	0.00000
29	4.795	-0.00033	6.184	-0.00158	79	1.281	0.00000	5.017	0.00000
30	4.741	-0.00030	6.282	-0.00107	80	1.239	0.00000	4.903	0.00000
31	4.681	-0.00024	6.373	-0.00060	81	1.198	0.00000	4.790	0.00000
32	4.617	-0.00015	6.458	-0.00019	82	1.158	0.00000	4.676	0.00001
33	4.548	-0.00007	6.537	0.00014	83	1.120	0.00000	4.562	0.00001
34	4.476	-0.00001	6.610	0.00041	84	1.082	0.00000	4.448	0.00000
35	4.400	0.00003	6.677	0.00060	85	1.046	0.00000	4.335	0.00000
36	4.322	0.00005	6.738	0.00073	86	1.011	0.00000	4.222	0.00000
37	4.242	0.00005	6.795	0.00080	87	0.977	0.00000	4.110	0.00000
38	4.159	0.00004	6.846	0.00083	88	0.944	0.00000	3.999	0.00001
39	4.075	0.00003	6.892	0.00081	89	0.912	0.00000	3.888	0.00001
40	3.990	0.00002	6.934	0.00077	90	0.881	0.00000	3.779	0.00001
41	3.904	0.00000	6.971	0.00071	91	0.852	0.00000	3.672	0.00001
42	3.817	-0.00001	7.003	0.00064	92	0.823	0.00000	3.565	0.00002
43	3.730	-0.00001	7.031	0.00056	93	0.795	0.00000	3.461	0.00002
44	3.643	-0.00001	7.054	0.00048	94	0.768	0.00000	3.357	0.00002
45	3.556	-0.00001	7.072	0.00041	95	0.741	0.00000	3.256	0.00003
46	3.469	-0.00001	7.086	0.00033	96	0.716	0.00000	3.156	0.00003
47	3.383	0.00000	7.096	0.00026	97	0.691	0.00000	3.058	0.00003
48	3.297	0.00000	7.100	0.00020	98	0.668	0.00000	2.962	0.00004
49	3.212	0.00000	7.100	0.00014	99	0.645	0.00000	2.868	0.00004
50	3.127	0.00000	7.095	0.00008	100	0.622	0.00000	2.776	0.00004

and plotted in Figures 4a and b. The impulse response $e(n)$ behaves as expected (Fig. 4a). We recall that $e(n)$ is the response of h_1 to a pulse of a_1 of unit amplitude, say 1 m./yr., lasting for 1 yr. from $n = 0$ to $n = 1$. One year after the start of the pulse $h_1 = 1 \cdot 084$ m. The pulse now ends. After a further year $h_1 = 1 \cdot 275$ m., and so on down the table. The fact that h_1 grows at first, rather than decays, is the instability phenomenon treated in Nye [I]. The annual increment in h_1 also grows at first, becomes a maximum between $n = 6$ and 7, and then diminishes. h_1 itself reaches a flat maximum of 4.967 m. at $n = 23$ —the maximum of the flood wave—and then slowly diminishes. Its fastest rate of fall is at $n = 43$ to 44. After 100 years, h_1 is still quite appreciable, 0.622 m. This, remember, is the result of a mere 1 m. of ice added to the glacier 100 yr. previously.

The behaviour of $g(n)$ is more complicated (Fig. 4b). $g(1) = 0.922$ and $g(2) = -1.085$. After this the variation settles down to an oscillation of decreasing amplitude. The g 's diminish much faster than the e 's, as forecast; after $n = 46$, $|g(n)| < 0.00001$. The values of $g(1)$ and $g(2)$ may be understood by considering the artificial situation where the glacier was a perfect integrator. Then all the $e(n)$ would be simply $\Delta t (= 1)$. a_1 would then be $\partial h_1 / \partial t$, or $a(1) = \{h(1) - h(2)\} / \Delta t$. Comparing with equations (9) we see that

$$g(1) = (\Delta t)^{-1} = 1, \quad g(2) = -(\Delta t)^{-1} = -1, \quad g(3) = g(4) = \dots = 0.$$

Thus the departures of $g(1)$ and $g(2)$ from the values 1 and -1, and the subsequent oscillations of $g(n)$, measure the extent to which the glacier is not a perfect integrator.

It is also illuminating to notice that after a pulse of unit height and length Δt the thickness of new material added to the glacier is Δt . Hence as $\Delta t \rightarrow 0$, $e(1)$ and $e(2)$ both approach Δt . It then follows from the first two equations of (10) that $g(1) \rightarrow (\Delta t)^{-1}$ and $g(2) \rightarrow -(\Delta t)^{-1}$. (In the continuum limit the g 's in fact involve the first derivative of a δ -function.)

The physical meaning of the $g(n)$ sequence is found by regarding the $g(n)$ as a series of a_1 values moving forward in time. The $g(n)$ sequence represents that time sequence of a_1 which would be necessary to produce a time sequence of h_1 in which the first value was 1 and all others were zero.

As a check on the numbers obtained for the two sequences we find

$$\sum_{n=1}^{100} e(n) = 275, \quad \sum_{n=1}^{100} g(n) = 0.00343,$$

compared with

$$\mu_0 = 292, \quad \lambda_0 = 0.00342,$$

[Nye IV, table I, col. (2)]. The first 100 terms thus give excellent agreement with equation (28) for the g 's; but, as is clear from their slow rate of decay, more than 100 e 's would be needed before their sum attained the limiting value μ_0 to 3 figures.

As a check to see whether $\Delta t = 1$ yr. was small enough the time interval was halved, but the pulse length was kept the same, now running from $n = 0$ to $n = 2$. This showed that the $e(n)$ computed with $\Delta t = 1$ yr. do indeed represent the true response to a unit rectangular pulse of duration 1 yr. to an accuracy of 0.3 per cent. We conclude that the basic premise, that we can work solely with annual values, is justified.

(ii) *Application of the $g(n)$ to the terminus record*

The record of the position of the terminus of South Cascade Glacier (Meier and Tangborn, 1965) (Fig. 5a) consists of observations in 1928,* 1953, and annually from 1955-63. The total length is thus 35 yr. The record of $a_1(t)$ (shown shaded in Figure 5b)† extends from 1952 to

* This is a photograph only recently discovered by Dr. Meier.

† a_1 is deduced from the mean specific net budget of Meier and Tangborn (1965, table II). The mean specific net budget is the specific net budget averaged over the current glacier surface, while a_1 is the specific net budget averaged over the datum glacier surface. Thus a_1 is equal to the mean specific net budget, with a small correction to take account of the changing area of the glacier.

1963 with a gap for 1953/54. It is not unreasonable to apply the foregoing theory and see to what extent the theoretical $a_1(t)$ agrees with that observed. (Some comparison has already been made in Nye [III].)

We must first fill in the gaps in the terminus record $l_1(t)$; this was done arbitrarily by linear interpolation for the years 1929–52 and for 1954. The record was also extrapolated back linearly before 1928. The angle θ in equation (4) was taken as the current value of 6.7 degrees. Then the $g(n)$ gave the record of a_1 by equations (9); it is shown in Figure 5b (unshaded). There is some correspondence with the observed a_1 record but it is not at all good; peaks occur in the right places, but they are all accentuated. The best agreement would be expected for the most recent points; detailed agreement ought to fall off into the past as the amount of information in the terminus record diminishes. On this basis the 1962/63 value is discordant.

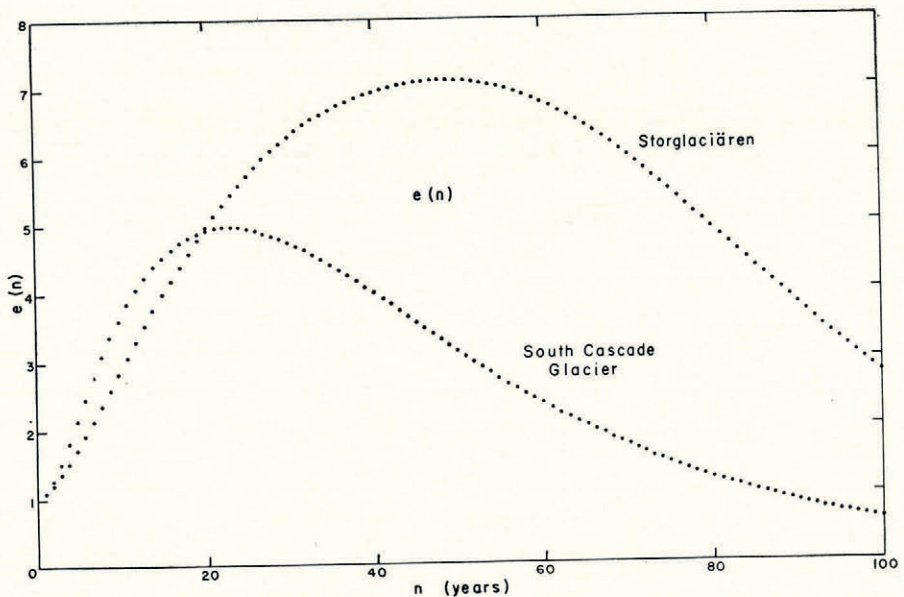

Fig. 4a. Influence coefficients $e(n)$ for the termini of South Cascade Glacier and Storglaciären. The curves also represent the response to a unit pulse

(The theoretical values for 1953/54 and 1954/55 are replaced by their mean because separately they depend heavily on the missing l_1 value for 1954.) The computed $a_1(t)$ before 1953 is linear and reflects the assumed linear retreat.

We have given the direct comparison between theory and observation. Now we must look a little more closely at possible sources of difficulty. To begin the discussion let us take note of the following well-known relation which must hold at the terminus of a glacier ending on land:

$$\dot{l}_1 = a_t \operatorname{cosec} \theta + u_t, \quad (29)$$

where \dot{l}_1 is the rate of advance measured along the bed, $-a_t$ is the rate of ablation measured perpendicular to the ice surface, u_t is the ice velocity parallel to the bed, and θ is the angle between the upper surface of the ice and the bed. (If ablation occurs at the bottom surface of the ice an extra term will appear.) This relation is a geometrical requirement and is quite independent of any theory of the sort we have been dealing with. The reason this simple formula cannot be used to relate the changing ablation-rate to the retreat of the glacier is that changes higher up the glacier will continually be propagated down and will change the values

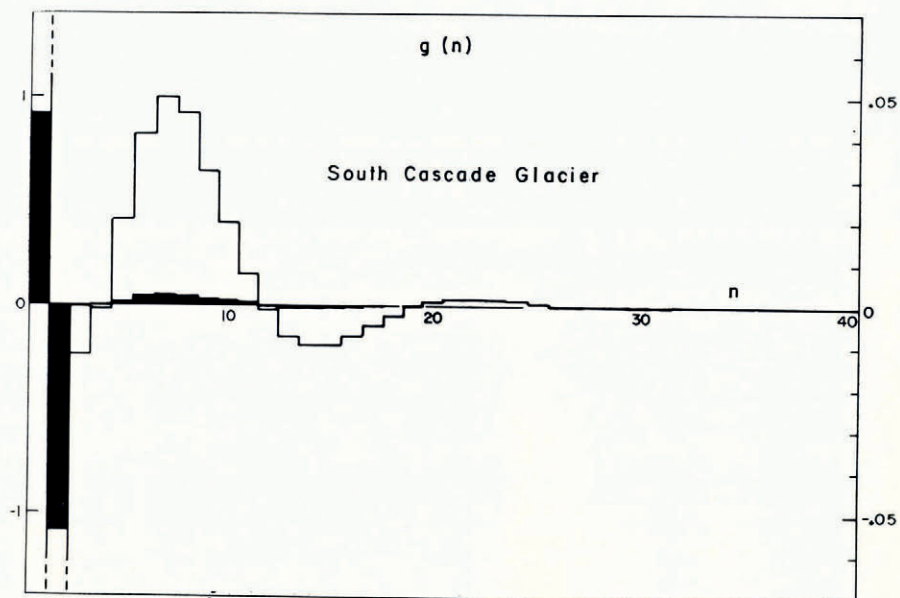

Fig. 4b. Coefficients $g(n)$ for South Cascade Glacier. The coefficients are shown as a step curve to emphasize their interpretation as a series of $a(n)$. Scale at left refers to filled-in curve. The unfilled-in curve (scale at right) shows the same data with scale enlarged 20 times

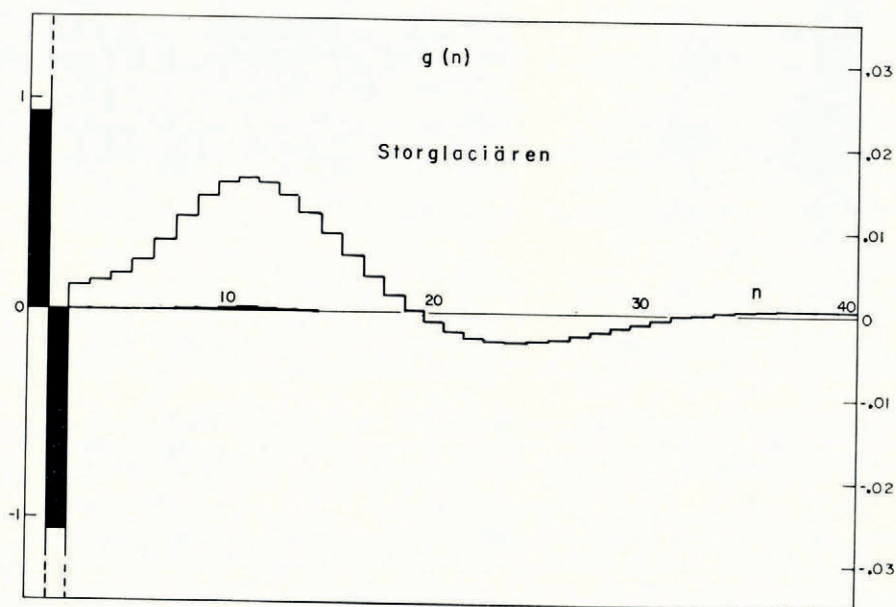

Fig. 4c. Same as Figure 4b, but for Storglaciären. Scale at left refers to filled-in curve. The unfilled-in curve (scale at right) shows the same data with scale enlarged 40 times

of θ and u_t . It could be said that our purpose in formulating the theory with kinematic waves and diffusion is precisely to deal with this difficulty. Nevertheless, over short enough periods θ and u_t will stay relatively constant, and then l_t will simply be linearly related by (29) to a_t .

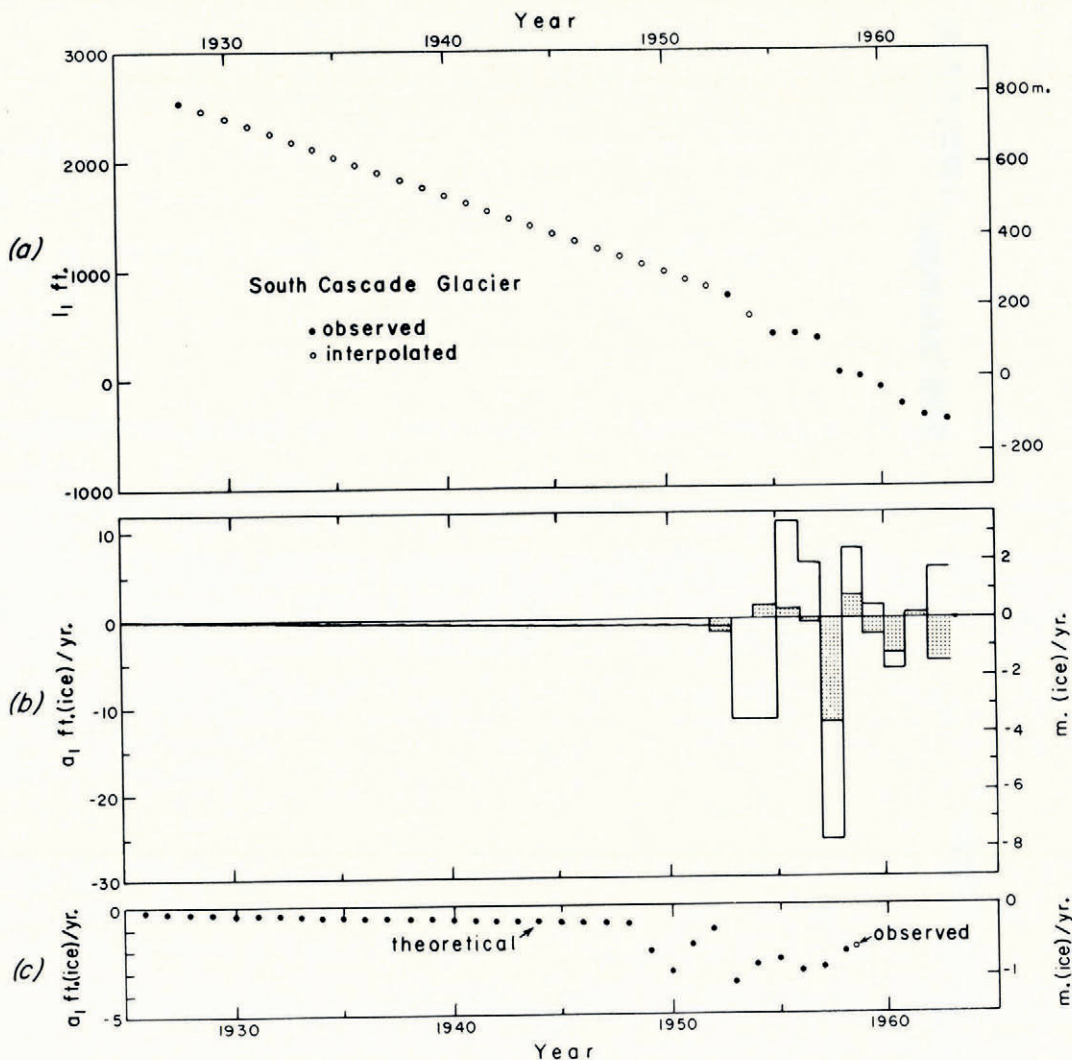

Fig. 5a. Record of terminus position of South Cascade Glacier. ● observed positions (Meier and Tangborn, 1965), ○ interpolated positions

Fig. 5b. South Cascade Glacier. Time variation of net budget. Shaded step curve: observed, inferred from data of Meier and Tangborn (1965). Unshaded step curve: computed from unsmoothed terminus record

Fig. 5c. South Cascade Glacier. Time variation of net budget. Dots show 10 yr. running means of values computed from terminus record; open circle, observed 9 yr. mean

Detailed consideration shows that over a short period like 6 yr. on South Cascade Glacier it is reasonable to take u_t and θ as constant. Let us then do so and plot l_t against a_t for the various years (Fig. 6). The points show a good deal of scatter. The straight line shown corresponds to the measured values $\theta = 6.7$ degrees and $u_t = 31.4$ ft./yr. (9.6 m./yr.). The errors shown for l_t are obtained from the errors in the individual l_t values given by Meier and Tangborn.

The average error in the ablation at the snout is perhaps ± 1 ft./yr. (0.3 m./yr.), so one sees at once that it is the error in measuring l_1 that is the source of the trouble. The ablation is measured with ample precision in most years, but the retreat rate is not.

Now South Cascade Glacier ends in a small lake, and it may be that this is the main cause of the scatter. For, in the first place, the occasional calving of the glacier into the lake causes abrupt changes in the terminus position; secondly, the geometry of the terminus does not strictly fulfil the conditions assumed in the derivation of equation (29). In these circumstances the proper comparison to make would be with the changing height of the ice surface at a

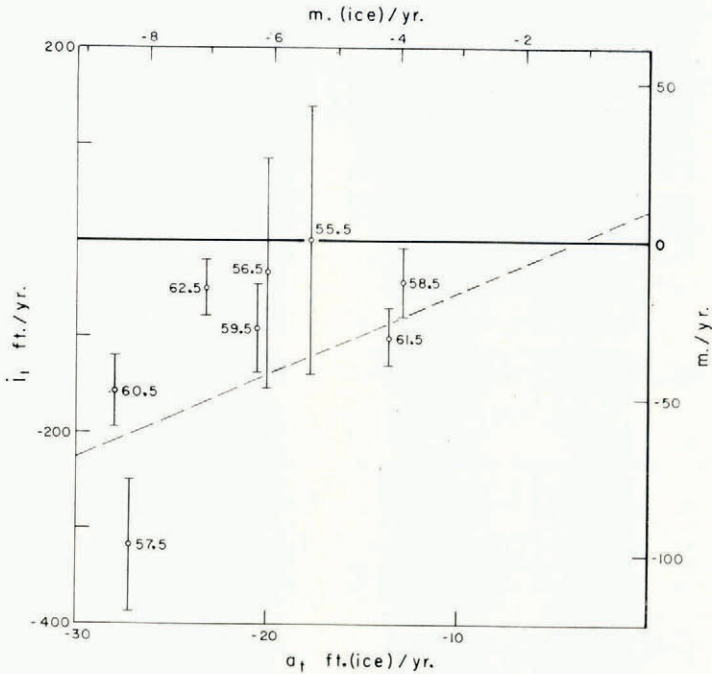

Fig. 6. South Cascade Glacier. Showing the poor correlation between $-l_1$, the measured annual retreat of the terminus, and $-a_1$, the measured annual ablation at the terminus

transverse section near the terminus, rather than with the changing terminus position, if these data were available for a sufficient number of years. Unfortunately they are not. Thus, the relevance of the theory to the existing data on year-to-year changes of this particular terminus is questionable. The calculation of a_1 with the g coefficients depends heavily on the *current* retreat rate; it is therefore not surprising that the correspondence in Figure 5b is rather poor.

Although it is evident that the details of the retreat curve cannot be used with much confidence, the average retreat rate over say 10 yr. is surely still significant. With this thought we have taken 10 yr. running means of the computed a_1 values. They are plotted on Figure 5c. For comparison we show the measured 9 yr. mean for 1954/55–1962/63. The agreement is very good. With the short terminus record of South Cascade Glacier we cannot go much further than this, except to deduce that on average the net budget was only very slightly negative in the 1930's and 1940's. It seems that for year-to-year fluctuations the geometry of the terminus and calving prevent effective use of the theory. But for longer-period trends the comparison between observation and calculation is favourable for the theory.

7. APPLICATION TO STORGLACIÄREN

(i) *Computation of the influence coefficients*

In Nye [IV] the observations of Dr. V. Schytt and Dr. E. Woxnerud on Storglaciären, Kebnekaise, Sweden, were used to deduce $B_0(x)$, $c_0(x)$ and $D_0(x)$ for this glacier. These tabulated functions were then used to find the $e(n)$ and $g(n)$ at the snout of Storglaciären shown in Table I and in Figures 4a and c. The general behaviour of $e(n)$ is the same as we have already seen but the time scale is about twice as long. The maximum of $e(n)$, the peak of the flood wave, is reached at $n = 48$ ($n(48) = 7 \cdot 100$) instead of $n = 23$ for South Cascade Glacier. The check whether $\Delta t = 1$ yr. was small enough for $e(n)$ to be a true representation of the impulse response showed that the maximum error was 0.08 per cent; the figure for South Cascade Glacier was 0.3 per cent; the smaller value for Storglaciären again reflects its longer time-scale.

The g 's (Fig. 4c) do not fall off as fast as one would wish:

$$\sum_{n=1}^{100} g(n) = 0.0014 \quad \text{compared with} \quad \sum_{n=1}^{\infty} g(n) = \lambda_0 = 0.0017.$$

The error incurred by not using enough g 's depends, of course, on the record of h_1 ; but if the record were steady we should obtain $0.0014 h_1$ instead of $0.0017 h_1$ as the value of a_1 , an error of 18 per cent.

(ii) *Application to the terminus record*

The terminus record of Storglaciären (Fig. 7a) goes back to 1897 with annual observations since 1944 (personal communication from V. Schytt; [Ahlmann and others], [1950]). The record of annual net budget obtained by Dr. Schytt and Dr. Woxnerud (personal communication from V. Schytt) extends from 1945 onwards.

The correlation between a_t and \dot{l}_t implied by equation (29) is again poor (Fig. 8). As with South Cascade Glacier the scatter is presumably due to difficulties with \dot{l}_t rather than with a_t ; but there is no lake to blame in this case. The difficulty seems to be one of sampling and averaging. Schytt points out (personal communication) that the retreat varies appreciably across the ice front and that the terminus shows relief in the transverse direction—that is, a variation both in position and in angle θ . During some summers parts of the front may stay snow-covered, and again during other summers moraine-covered. Nevertheless, in spite of these complications, if all quantities in equation (29) are measured at strictly the same point on the terminus, the equation should hold precisely—apart from bottom melting. It should also hold precisely if all quantities are averaged, in an appropriate way, across the terminus. It is presumably the difficulty of finding precise averages from a limited number of points that prevents a better year-to-year correlation between a_t and \dot{l}_t , interpreted as averages across the glacier. A further reason for discrepancy is that the survey of the front is very seldom simultaneous with the end of the budget year; the error in l_t from this source could be about 2 m. (personal communication from V. Schytt).

In this situation it is plain that we must be very cautious in attaching significance to the observed annual fluctuations in \dot{l}_t . Bearing this clearly in mind, let us nevertheless see what happens if, just for the moment, we take the observed l_t values literally and fill in gaps by linear interpolation and extrapolation (not shown in Figure 7a). The result for a_1 (using $\theta = 18.2$ degrees) is shown in Figure 7b by the unshaded step curve. The sharp changes at 1908 and 1922 merely reflect the arbitrary assumption made to fill in the l_t record.

We now wish to compare this theoretical $a_1(t)$ curve with observation. As illustrated in Nye [IV], the observed $a_1(x, t)$ shows some dependence on x from year to year on Storglaciären, although when averaged over several years the approximation $a_1(x, t) = a_1(t)$ is roughly obeyed. The question arises therefore of how best to interpret the $a_1(t)$ of the theory in this

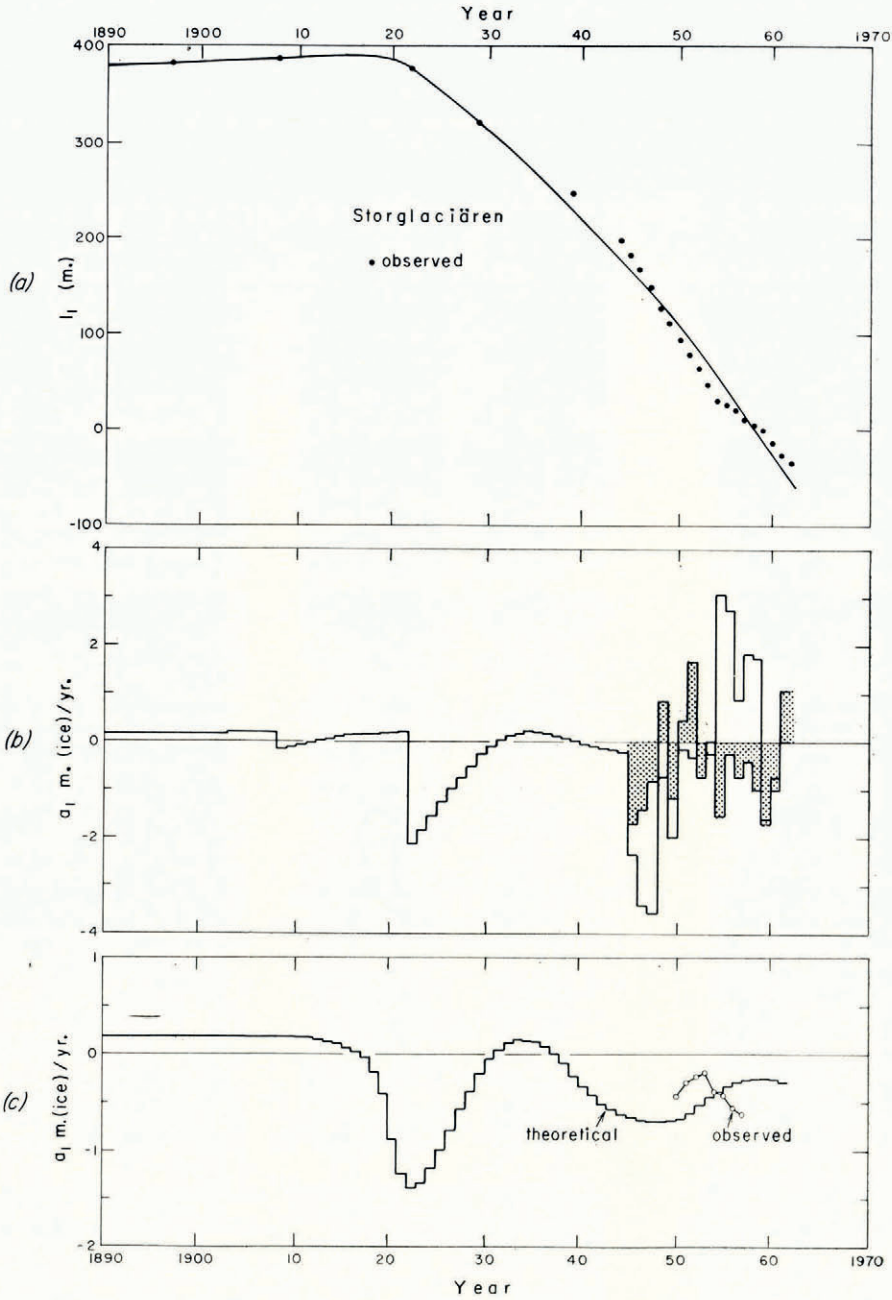

Fig. 7a. Record of terminus position of Storglaciären. Dots show observed positions (personal communication from V. Schytt, [Ahlmann and others,] [1950]). Curve shows smoothed position used for computation

Fig. 7b. Storglaciären. Time variation of net budget. Shaded step curve: observed, inferred from data of Schytt and Woxnerud (personal communication from V. Schytt). Unshaded step curve: computed from unsmoothed terminus record

Fig. 7c. Storglaciären. Time variation of net budget. Step curve is computed from the smoothed terminus record. Open circles show 10 yr. running means of observed values

case. One way is to take it as an average down the glacier. However, it seems better to take it as the $a_1(t)$ measured at the terminus. By doing this we preserve the theoretical correlation between rate of retreat and ablation rate at the terminus for short-period changes—and for long-term changes it does not matter what point on the glacier is chosen for measuring $a_1(t)$. In this way we may hope to make use of the short-period information in the computed a_1 —which we should otherwise have to discard as not meaningful. Accordingly, the a_1 values shown in Figure 7b as observed (shaded step curve) are in fact a_1 at the current glacier terminus. There is some relation between observed and calculated values. That the relation is not closer we believe to be due primarily to the difficulty of measuring l_1 (averaged across the terminus), as evidenced by Figure 8.*

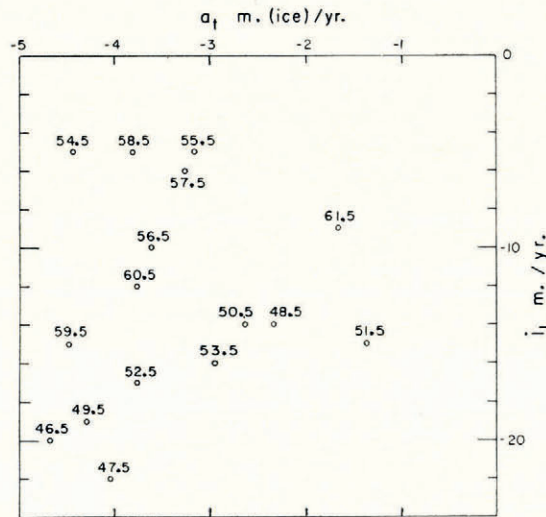

Fig. 8. Storglaciären. Showing the poor correlation between $-l_1$, the measured annual retreat, and $-a_1$, the measured annual ablation at the terminus

Again, as with South Cascade Glacier, it seems we must attach little weight to the annual fluctuations of l_1 , but we should be entitled to trust the general trend. Therefore we have drawn a smooth curve (Fig. 7a) through the points for 1897, 1908, 1922 and 1929, and passing evenly among the 1944–62 points. The a_1 step curve calculated from this smooth curve is shown in Figure 7c. We believe the trends to be significant, but of course the values must become less reliable as they go into the past, and as the information in the l_1 record diminishes. For example, the linear trend before 1908 is purely the result of the linear interpolation between 1908 and 1897 and the quite arbitrary linear extrapolation before 1897. The sharp down-turn in the l_1 record about 1920 is reflected in the sharp decrease of a_1 at this time (note, no time lag). But, interestingly, even though a_1 returned to zero about 1930 the retreat still continued, because of effects from the early 1920's propagated down the glacier. Looked at in another way, if a_1 had not risen in the 1930's the retreat caused by the pulse in the 1920's would have accelerated, by the instability effect—for the $e(n)$ show that the greatest rate of retreat after a negative pulse occurs 10 yr. after the pulse. However, a reduction in a_1 in the

* The points in Figure 8 fall into two groups, before and after 1954. This is clearly related to the sharp change in observed recession rate in 1954 seen in Figure 7a. Note also in Figure 7b that all the calculated a_1 are less than the observed values before 1954 and are greater than the observed values after 1954 (1961/62 is an exception). There is nothing in the observed a_1 values to account for such a change in recession rate in 1954. We therefore believe that it is either spurious or due to some effect outside the present theory.

late 1930's was needed to sustain the retreat. The theory finds that a_t has been fairly constant between -0.3 and -0.7 m. of ice/yr. since 1940. The 10 yr. running mean of the observed a_t (at the terminus) is also shown in Figure 7c. It agrees quite well. By taking other smooth curves through the L_t data the agreement could probably be made even better.

One complication should be mentioned (personal communication from V. Schytt). Our theory assumes that the slope of the bed is much the same at the successive positions of the terminus. Before about 1935-40 the slope of the bed was in fact opposite in sign to the slope of the ice surface; subsequently it was the same. The main effect, presumably, will be to make θ larger for the earlier years than the value we have taken. Thus, for these years, we have underestimated the absolute magnitude of a_t .

Our conclusion is that, just as for South Cascade Glacier, the observed year-to-year fluctuations of the terminus cannot be used with any certainty to obtain the annual budget; but the general trend of advance and retreat over longer periods gives a mean a_t that agrees well with recent observation. We therefore think that the curve in Figure 7c, with its maximum in the 1930's, has genuine significance, and extends the budget record back into the period before it was measured. In saying this we must repeat the proviso that the curve necessarily becomes less trustworthy as it goes into the past.

8. ACKNOWLEDGEMENTS

I must again express warm thanks to Dr. V. Schytt, Dr. E. Woxnerud, Dr. M. F. Meier and Mr. W. Tangborn for making available their observations before publication. Dr. Schytt and Dr. Meier have also reviewed the manuscript most helpfully—but, naturally, they must not be held responsible for its shortcomings. Most of the computations were done on the I.B.M. 709 digital computer at Yale University; a few were done on an I.B.M. 7094 digital computer at the University of California at Los Angeles.

MS. received 24 August 1964

REFERENCES

- [Ahlmann, H. W., and others.] [1950.] Variations des glaciers en Suède, Islande et Norvège, [par H. W. Ahlmann, J. Eythórsson, K. Fægri et W. Werenskiöld]. *Union Géodésique et Géophysique Internationale. Association Internationale d'Hydrologie Scientifique. Assemblée générale d'Oslo 19-28 août 1948. Procès-verbaux des séances*, Tom. 2, p. 257-61.
- Crank, J., and Nicholson, P. 1947. A practical method for numerical integration of solutions of partial differential equations of heat-conduction type. *Proceedings of the Cambridge Philosophical Society*, Vol. 43, Pt. 1, p. 50-67.
- Meier, M. F., and Tangborn, W. V. 1965. Net budget and flow of South Cascade Glacier, Washington. *Journal of Glaciology*, Vol. 5, No. 41, p. 547-66.
- Nye, J. F. 1960. [Nye I.] The response of glaciers and ice-sheets to seasonal and climatic changes. *Proceedings of the Royal Society, Ser. A*, Vol. 256, No. 1287, p. 559-84.
- Nye, J. F. 1963[a]. [Nye II.] On the theory of the advance and retreat of glaciers. *Geophysical Journal of the Royal Astronomical Society*, Vol. 7, No. 4, p. 431-56.
- Nye, J. F. 1963[b]. [Nye III.] The response of a glacier to changes in the rate of nourishment and wastage. *Proceedings of the Royal Society, Ser. A*, Vol. 275, No. 1360, p. 87-112.
- Nye, J. F. 1965. [Nye IV.] The frequency response of glaciers. *Journal of Glaciology*, Vol. 5, No. 41, p. 567-87.
- Richtmyer, R. D. 1957. *Difference methods for initial-value problems*. New York, Interscience.